



BAYCO
Golf



CATALOG 2021

Our Name Stands for *Quality*

Bayco Golf has been an industry leader in golf course accessories since 1986. Our products are found on the most prestigious golf courses all around the world! With almost 40 years of experience and our diverse line of products, we can meet the needs and outfit any type or size of golf course. No job is too big or small – whether you are constructing a 36-hole resort course or a small putting green in your back yard, we have what you are looking for!

Get on course with **BAYCO!**

Call us today to place your order 1 (877) 668-4653



Featured PRODUCTS

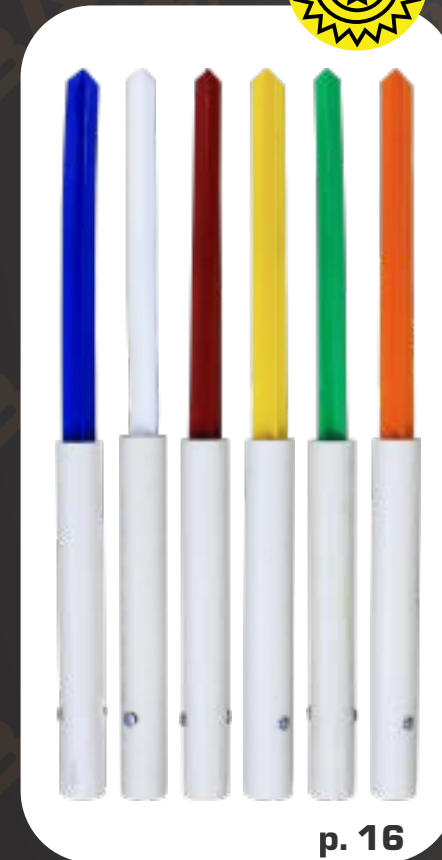

p. 16

ColorFlex Marker

A flexible distance marker that allows the superintendent to mow the greens without removing it.



p. 25

Mully Cup Lifter

Touchless ball lifter reduces flag pole - golfer contact and bending while retrieving the ball.



p. 33

InstaFix

New and improved ball mark repair tool. No moving parts, one solid piece of aluminum.



Bayco Golf proudly sources more than 95% of its products from North American manufacturers and suppliers.

TABLE OF CONTENTS

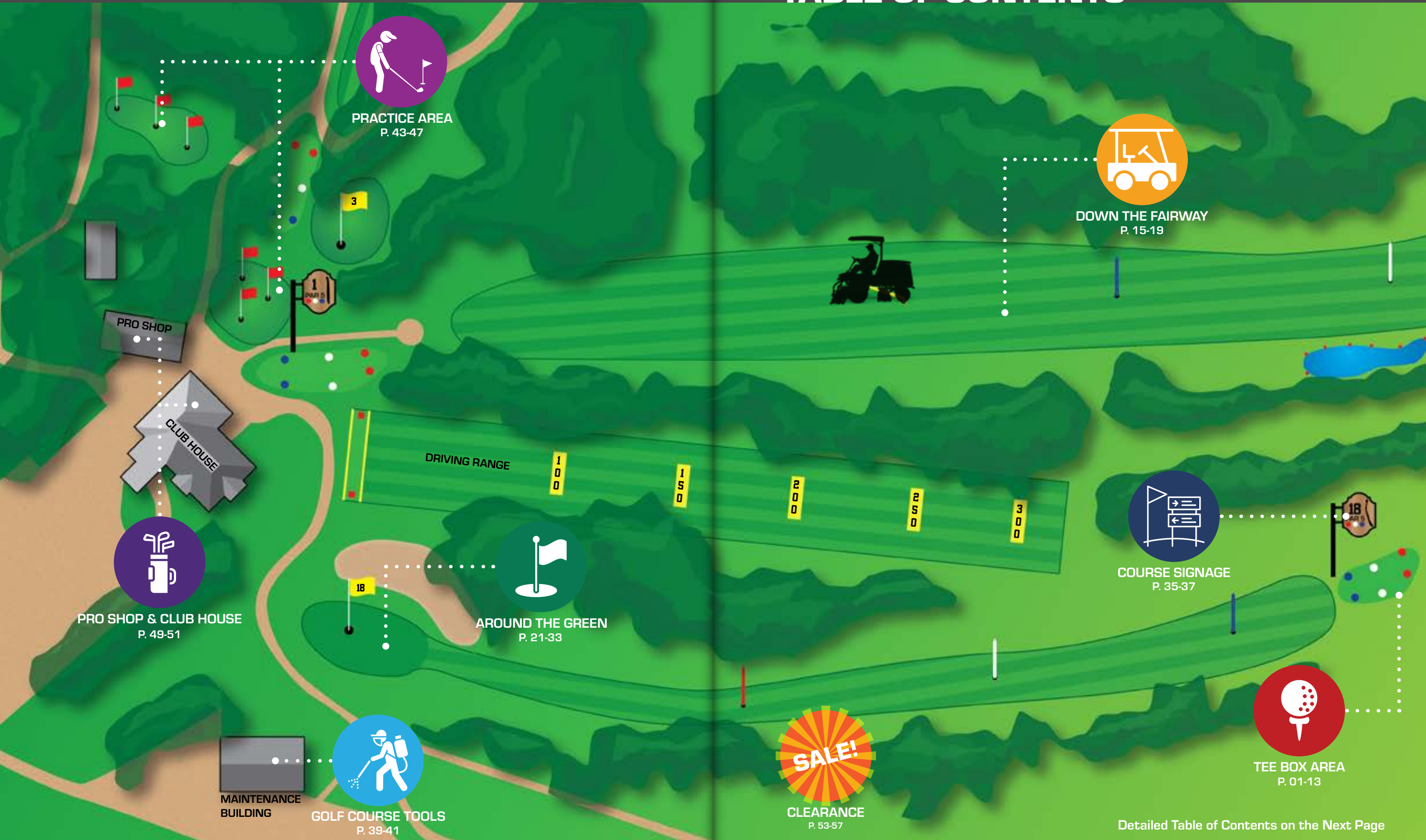

PRACTICE AREA
P. 43-47



DOWN THE FAIRWAY
P. 15-19

PRO SHOP

CLUB HOUSE

DRIVING RANGE

100

150

200

250

300



PRO SHOP & CLUB HOUSE
P. 49-51



AROUND THE GREEN
P. 21-33



COURSE SIGNAGE
P. 35-37

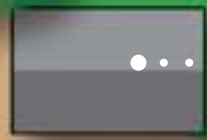

MAINTENANCE
BUILDING



GOLF COURSE TOOLS
P. 39-41



TEE BOX AREA
P. 01-13



CLEARANCE
P. 53-57

Detailed Table of Contents on the Next Page



TABLE OF CONTENTS

TEE BOX AREA	1	COURSE TOOLS	39
Ball Washer Ensemble	2	Soil Samplers & Aerators	40
Plunger Style Aluminum Ball Washers	4	Other Essential Course Tools	41
Ensemble Accessories	5		
Crank Style Ball Washer; Club Washer	6	PRACTICE AREA	43
Tee Towels and Detergents	7	Practice Markers & Flag Poles	44
Litter Baskets	8	Practice Flags; Chipping Greens Ball Pusher	45
Designer Series Litter Bins	9	Range Club Washer & Flags	46
Sand & Seed Bottles	10	Range Banners	47
S & S Bottle Rack and Divot Mix Containers	11		
Benches and Water Coolers	12	PRO SHOP & CLUBHOUSE	49
Broken Tee Caddies and Tee Markers	13	Spike Cleaner Stands & Brushes	50
		Bag Racks, Ashtrays, & Other Related Items	51
DOWN THE FAIRWAY	15		
Color Flex Distance Markers	16	CLEARANCE	53
Recycled Plastic Rope Stakes and Markers	17	Clearance Practice Flags	54
Fairway Markers and Rope	18	Clearance Greens Flags	55
Marking Paint and Tools	19	Clearance Markers and Cups	56
		Flagpoles	57
AROUND THE GREEN	21		
Hole Cutter and Accessories	22	ABOUT BAYCO	58
Hole-In Paint & Tools; Cup Pullers; Trimmers	23	INDEX	60
Greens Cups	24		
Cup Setters , Covers, & Liners; Mully Cup	25		
Regulation Poles (1/2")	26		
Tournament Poles (3/4")	27		
Flag Pole Guards; Reflectors & Smart Sticks	28		
Greens Flags & Accessories	29		
Custom Flags	30		
Sand Trap Rakes & Parts; Handle Guards	32		
Coco Mats and Other Greens Tools	33		
		COURSE SIGNAGE	35
		Steel Signs, Easels, & Fairway Markers	36
		Aluminum, Directional & Tee Signs	37



Toll Free Phone Number:
1 (877) 668-4653

www.BAYCOGOLF.com

Ph: (204) 633-8881
 Fax: (204) 633-6226
 E-Mail: contact@baycogolf.com

TEE BOX AREA

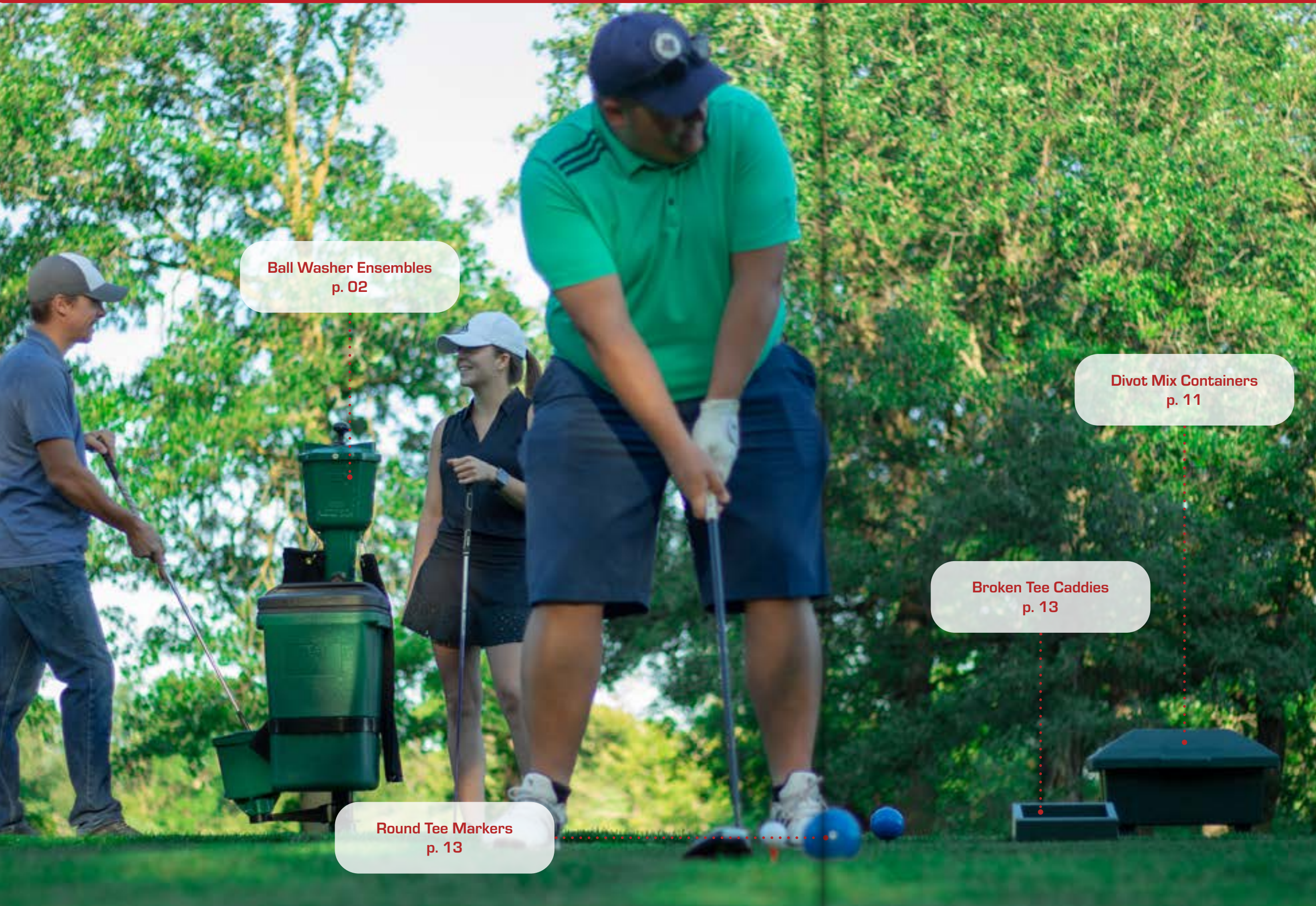

Ball Washer Ensembles
p. 02

Divot Mix Containers
p. 11

Broken Tee Caddies
p. 13

Round Tee Markers
p. 13

PG	ITEM
02	Ball Washer Ensemble Examples
04	Plunger Style Ball Washers
05	Ensemble Accessories
06	Crank Style Ball Washers
06	Aluminum Club Washers
07	Tee Towels
07	Detergents
08	Litter Baskets
09	Designer Series Litter Bins
10	Sand & Seed Bottles
11	Sand & Seed Bottle Racks
11	Divot Mix Containers and Scoops
12	Benches
12	Water Coolers
13	Broken Tee Caddies
13	Tee Markers



Ball Washer Ensemble



Trash Lid [No. 766T]

34" Stand Pipe [No. 702A]

Designer Series Plastic Litter Bin - Green [No. 765G]

Stand Base - Green [No. 701G]

Plunger Style Ball Washer - Green [No. 700]

Can Lid [No. 766C]

Cotton Tri-Fold Towel [No. 731G]

Double Mounting Bracket [No. 747]



Cotton Tri-Fold Towel - Black [No. 731BK]

34" Stand Pipe [Black] [No. 702A]

Designer Series Plastic Litter Bin - Green [No. 765G]



Foot Brush [No. 610]

Stand Base - Green [No. 701G]

Plunger Style Ball Washer - Green [No. 700]

Cotton Tri-Fold Towel - Green [No. 731G]

Can Lid [No. 766C]

Green Club Washer [No. 690G]

Single Mounting Bracket [No. 746]

Pipe Mount [No. 761]



Completely customizable with any of our interchangeable ensemble components. Mix and match colors, towels, can lids, ball washers and more!

Don't forget to ask us about customizing your ensemble with your course logo. The combinations and possibilities are endless!

Plunger Style Aluminum Ball Washers

PLUNGER STYLE BALL WASHERS

All of our ball washers are proudly made in North America. They consist of cast-in-mold aluminum alloy and feature durable polymer and stainless steel internal components, providing years of trouble free service.

● Green ● Red ● Black ● Copper Vein
* Custom colors are available.



Plunger Style Ball Washer [No. 700]

Our standard ball washer.
Capacity: 7.2 US Pints
Cleans 1 ball at a time.



INCLUDED:

- Easy grip replaceable agitator knob
- Flanged cover does not seize and is easy to remove
- Brush assembly firmly fastened underneath cover with stainless steel cap screws
- Powder coated color finish (glass hard) ensures durable and beautiful color for years

● Green ● Red ● Black ● Copper Vein
* Custom colors are available.



Plunger Style Ball Washer [No. 699]

Our smaller model is manufactured to the same standards as the 700 ball washer.
Capacity: 5 US Pints
Cleans 1 ball at a time.



PLUNGER STYLE BALL WASHER PARTS



Plunger Style Repair Kit [No. 721KIT]

The repair kit fits all quality brand plunger style units. Includes all parts listed below (also sold separately).

1. Snap Hook Assembly [No. 716AS]
2. Rubber Drain Plug Gasket [No. 717]
3. Drain Plug Wrench [No. 714]
4. Drain Plug [No. 713]
5. Alan Keys (available only in the kit)
6. Brush Assembly [No. 712AS]
7. Agitator Assembly [No. 711AS]



8. Foot Brush w Screws [No. 610]
Brushes can be attached to the 701 base with the provided screws. Two brushes per base, sold individually.
9. Spikes for Base [No. 801-3]
Secures ball washer base to the ground, sold in set of three.

Ensemble Accessories

PLUNGER STYLE BALL WASHERS, CONT.

● Green ● Red ● Black ● Copper Vein
* Custom colors are available.



Custom Plunger Style Ball Washer [No. 770]

Manufactured to the same standards as the 700 ball washer, the 770 model can be customized with a logo.
Capacity: 7.2 US Pints
Cleans 1 ball at a time.



Ball Washer Wall Mount [No. 692]

Allows the ball washers to be attached to any wall. Works with the aluminum club washers, as well. Hardware not included due to the wide variety of wall materials.
Sold in black only.

The stand pipe and base (sold separately) are made to standard and fit all of our ball washer units.

● Green ● Red ● Black ● Copper Vein
* Custom colors are available.



Ball Washer Stand Base [No. 701]

1. 34" Stand Pipe [No 702A] *Pipes sold in black only.
2. 46" Stand Pipe for direct burial [No. 704-6A]



Crank Style Ball Washer; Club Washer

CRANK STYLE BALL WASHERS

- Industry exclusive
- Easy lift cover with hinges
- Powder coated color finish (glass hard) ensures durable and beautiful color for years
- Unique brush style cleans more than one ball at a time
- Features **NEW** handle design!

- Green ● Red
- Black ● Copper Vein



Crank Style Ball Washer [No. 778]

Manufactured to the same standards as the plunger style ball washers, the crank style model is able to clean multiple balls at a time.
Capacity: 7.2 US Pints
Cleans 4 balls at a time.

CRANK STYLE BALL WASHER PARTS



Crank Style Repair Kit [No. 779KIT]

Includes all parts listed bellow (also sold separately).

- 1. Brush Holder Assembly [No. 777-3]**
- 2. Complete Handle [No. 777-4]**

ALUMINUM CLUB WASHERS

Durable, cast-in-mold aluminum alloy and powder coated inside and out, this tough club washer provides many years of care-free service. Includes two easily replaceable scrub brushes and a 3/4" drain plug.

- Green ● Red ● Black ● Copper Vein



Aluminum Club Washer [No. 690]

CLUB WASHER PARTS

- Green ● Red ● Black



Club Washer Flanged Base [No. 650]

Install your club washer anywhere! Works for hard and soft surfaces, simply install with 4 spikes or bolts.



1. Replacement Brush [No. 690-3]

Two brushes per Club Washer. Sold individually.

2. Club Washer Pipe Mount [No. 691]

Attaches to the 702A and 704-6A Ball Washer Stand Pipes to complete your Ensemble.

Tee Towels and Detergents

RELATED ITEMS

Tee towels available to further compliment your ball washer ensemble. The towels can be attached using 716 Snap Hook and Key Ring Assembly (available with every ball washer).



1. Cotton Corner Grommet Tee Towel [No. 725]

Smooth cotton fibers deliver a light, thin, fast drying fabric. Sold in green only. 12 towels/pkg.

2. Elite Cotton Center Grommet Towel [No. 730BK]

100% cotton with smooth cotton threads producing a very soft feel. Sold in black only. 12 towels/pkg. Embroidery available, please contact us.

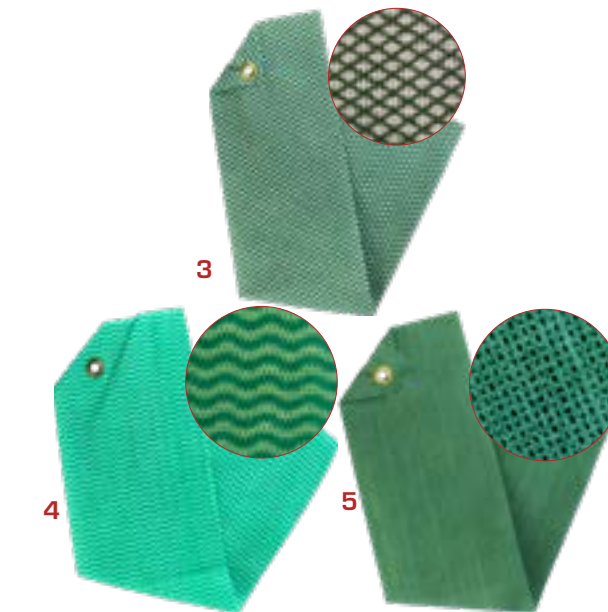

3. Economy Corner Grommet Tee Towel [No. 726]

4. Classic Corner Grommet Tee Towel [No. 728]

5. Premium Corner Grommet Tee Towel [No. 729]

Strong, absorbent, and soft disposable towels. 200 towels/pkg.

DETERGENT

Our detergents leave balls sparkling clean and remove the residue in the ball or club washer.



6. Detergent Soap Tablets [No. 718T]

450 tablets/container. One tablet per ball or club washer fill.

7. Heavy Duty Detergent [No. 718]

4L container. Mix 1 part concentrate to 4 parts water



Tri-Fold Cotton Central Grommet Towel [No. 731]

8. Green Towel [No. 731G1]

9. Black Towel [No. 731BK]

Smooth cotton fibers deliver a light, thin, fast drying fabric. Sold in green and black. 12 towels/pkg.

Litter Baskets

The litter baskets are available in 9 gal size and in five different colors*. Made with 20 gauge steel and with powder coated finish. Available in three different bases to fit your application requirements.

● Red ● Green ● Black

Bases available only in black

* Custom colors are available upon request.



- 1. Litter Basket with Spike Base [No. 750]**
Perfect for installing into a soft surface, such as grass.
- 2. Litter Basket with Flat Base [No. 754]**
Sturdy base for any application.
- 3. Litter Basket with Cone Base [No. 755]**
Sturdy base for any application.

LITTER BASKET PARTS

OTHER ATTACHMENTS



- 4. Steel Spike Base [No. 750-5]**
- 5. Flat Base [No. 759]**
- 6. Cone Base [No. 760]**

- 7. Stand Base Mount [No. 745]**
Attaches to the 701 base stand in the same fashion as the 610 foot brush.
- 8. Pipe Mount [No. 691BK]**
Attaches to the 702A and 704-6A Ball Washer Stand Pipes and fits the 750 Litter Basket with Spike Base



Designer Series Litter Bins

Made of strong polyethylene plastic, these litter bins are ergonomically designed to add elegance to both the ball washer ensemble and on their own. Available with three different lid styles to suit your needs.

● Green ● Black ● Red ● Blue



Designer Series Plastic Litter Bin [No. 765]



- 1. Trash Lid [No. 766T]***
- 2. Solid Lid [No. 766S]***
- 3. Can Lid [No. 766C]***

*Sold in black only and separately from bins.

LITTER BIN PARTS



- 4. Single Mounting Bracket [No. 746]**
- 5. Double Mounting Bracket [No. 747]**

Mounts wrap around a 2" Ensemble Pipe and can support one or two Litter bins at a time.

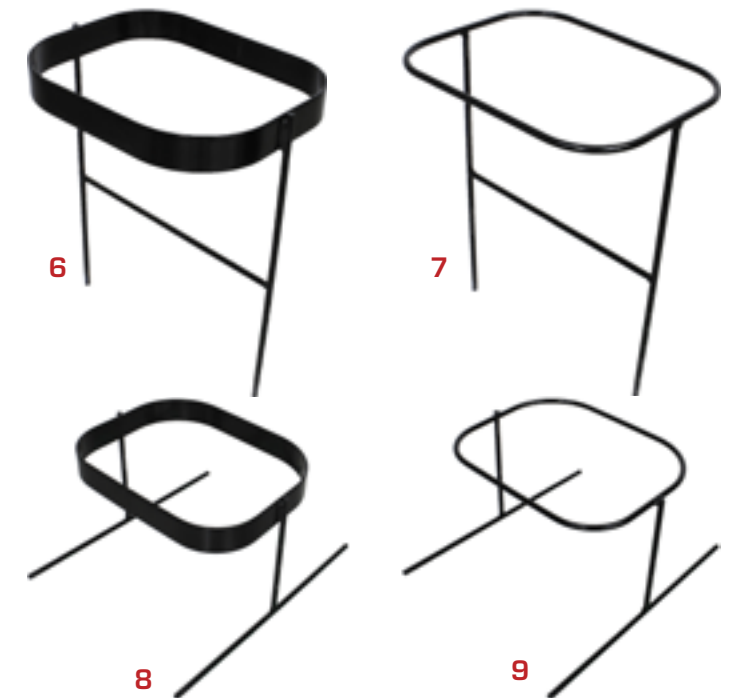

- 6. Heavy Duty In-ground Stand [No. 748A]**
- 7. Standard In-ground Stand [No. 748B]**
- 8. Heavy Duty Above Ground Stand [No. 748C]**
- 9. Standard Above Ground Stand [748D]**

The Litter Bin Stands allow them to be installed anywhere and on any surface. Choose between standard and heavy duty metal.

Sand & Seed Bottles

All of our sand and seed bottles have a screw on/off bottom lid with wide opening for easy filling. Made of heavy duty plastic. Ergonomically designed for easy transportation with a narrower base, our rattle proof bottles fits on any bottle holder and prevent the bottle from rattling.



1. Rattle Proof Sand and Seed Bottle [No. 234R]

1.3L Capacity; Fits our 245 Bottle Holder

2. Rattle Proof Sand and Seed Bottle with Handle [No. 234H]

1.3L Capacity; Attaches to our 243 Bottle Rack

Replacement Bottle Handle Assembly [No. 234AS]

3. Rattle Proof Sand and Seed Bottle with Modded in Handle [No. 234HR]

1.3L Capacity; Built-in handle



7. Replacement Screw-On Cap [No. 234H-3]

Replacement cap for #234 and #234H bottles

8. Replacement Screw-On Cap [No. 234R-1]

Replacement cap for #234R and #234RH bottles

A slimmer solution with an air tight lid that pops on and off for easier refill and a clip which allows it to snap onto any golf bag with ease.



5. Personal Sand and Seed Bottle [No. 234P]

0.5L Capacity

6. Replacement Parts for 234P [No. 234P-KIT]

Replacement bottom cap, top lid, and clip.



9. Sand and Seed Bottle Holder [No. 245]

A simple solution to attach the Sand & Seed bottles to virtually any cart. Please contact us for a quote.

No. 245 for No. 234 Bottle
 No. 245Y for No. 234R Bottle (Yamaha)
 No. 245U for No. 234R Bottle (Universal)
 No. 245EZ for No. 234R Bottle (E-Z-Go)
 No. 245CC for No. 234R Bottle (Club Car)

S & S Bottle Rack and Divot Mix Containers

Four racks on each side hold up to 10 bottles/rack.

Rear handle for easy push or pull of the rack.

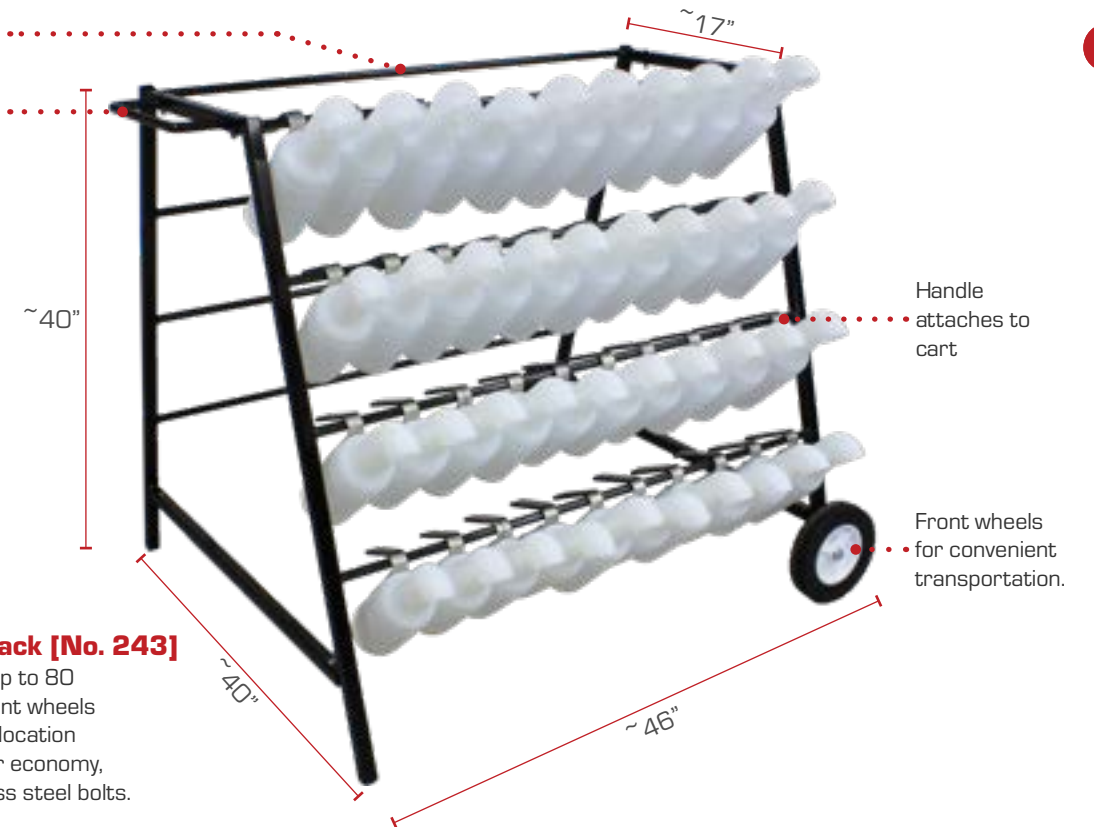

Sand and Seed Bottle Rack [No. 243]

Convenient mobile rack, holds up to 80 bottles.* Complete with two front wheels and a rear lift handle making relocation easy and practical. Ships flat for economy, assembles easily with 8 stainless steel bolts.

*Bottles sold separately.

Made of maintenance free, polyethylene plastic material. These divot containers are ideal for the tee or range areas. The lid is engineered to keep the mix dry while providing easy access.

Simple, ergonomic, polyethylene plastic scoop for your divot mix container



Divot Mix Container (M) [No. 696]

● Brown ● Green ● Black

16.8L Capacity; 16 oz plastic scoop included with every container.
 Approx. size (LxWxH): 19.5"x14"x16"

Divot Mix Container (L) [No. 697]

● Green

42.4L Capacity; 16 oz plastic scoop included with every container.
 Approx. size (LxWxH): 23.5"x16"x18"

8 oz Plastic Scoop [No. 233]
16 oz Plastic Scoop [No. 233-01]

Benches and Water Coolers

All benches made with 2"x6" ultraplast recycled plastic for longevity and durability. Ships flat for economy and convenience. All necessary hardware included.



Grey Redwood Green



Grey Redwood Green



Grey Redwood Green



Tan



Tan

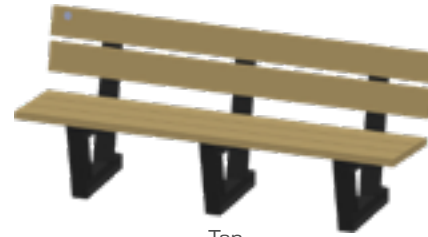

Tan

- 5' Deco Bench**
 Grey [No. EE1170]
 Redwood [No. EE1179]
 Green [No. EE1174]
 Tan [No. EE1178]

- 6' Deco Bench**
 Grey [No. EE1190]
 Redwood [No. EE1193]
 Green [No. EE1194]
 Tan [No. EE1198]

- 6' Standard Bench**
 Grey [No. EE1210]
 Redwood [No. EE1213]
 Green [No. EE1214]
 Tan [No. EE1218]

Quality insulated containers with heavy duty construction. Ensures water remains cool even on hot days. Replacement liners available [No. T1000 - 50/box]



1. Lock and Key [No. 282C]
 2. Replacement Bracket (plastic) [No. 282CLIP]
 3. Replacement Bracket (steel) [No. 279-4]
 4. 10 Gal. Water Cooler [No. 282G]
 5. 5 Gal Water Cooler [No. 281]



6. Lever Style Spigot [No. 282]
 7. Pinch Tube Spigot [No. T600]
 8. Push Button Spigot [No. 282SPIG]

Dispensers can hold approx. 200 solo cups* at a time. They come complete with a mounting bracket that attaches easily to 282CLIP and 279-4 brackets.



9. Stainless Steel Cup Dispenser [No. 283]
 10. Plastic Cup Dispenser [No. 283P]
 11. 4 oz Solo Cups [No. 288]
 Sold in cases of 5,000 only.

Broken Tee Caddies and Tee Markers

The broken tee caddies act as distance markers as well as receptacles for broken tees with two drainage holes on the bottom to prevent water build up.

- Black ○ White ● Green ○ White ● Blue
 ● Red ● Yellow ● Blue ○ Yellow ● Red
 *Custom colors are available.



- Aluminum Broken Tee Caddy [No. 808]**
 Raw/Unfinished Caddies are available.



- Plastic Broken Tee Caddy [No. 815]**
 While quantities last.

Made of recycled plastic lumber, this caddy stands 4" tall and has a steel mesh base.

- Green



- Recycled Plastic Broken Tee Caddy [No. E803G]**

Made of 1/8" thick steel with powder coated finish. Custom decals and colors are available.

- White ● Yellow
 ● Red ● Blue



- Tear Drop Tee Marker [No. 816]**
 Raw/Unfinished Markers are available.

Made of aluminum with powder coated finish. Each marker comes complete with a stainless steel spike.

- Black ○ White ● Yellow
 ● Red ● Green ● Blue
 *Custom colors are available.



- Solid Aluminum Tee Marker [No. 820]**
 Raw/Unfinished Markers are available.

Made of durable polyethylene plastic material. Color impregnated for longevity. Each marker is complete with a spike.

- Yellow ● Red
 ● Blue ● Black
 ○ White



- Round Plastic Tee Markers**
 1. 3" Solid Tee Marker [No. 810]
 2. 5" Hollow Tee Marker V1 [No. 811]
 3. 5" Solid Tee Marker [No. 812]
 4. 5" Custom Solid Tee Marker [No. 813]
 Custom Decals Available (clearance)
 5. 5" Hollow Tee Marker V2 [No. 814]

DOWN THE FAIRWAY



Marking Wand
p. 19

Hazard Markers
p. 17

Braided Rope
p. 18

Rope Stakes
p. 17

ColorFlex Distance Markers
p. 16

PG	ITEM
16	ColorFlex Markers
17	Color Flex Installation Kit
17	Recycled Plastic Rope Stakes
17	Recycled Plastic Hazard Markers
18	Fairway Distance Markers
18	SMP Fairway Markers
18	Bungee and Braided Ropes
19	Marking Wands and Pistols
19	Rust-Oleum Marking Paint



Color Flex Distance Markers

COLOR-FLEX DISTANCE MARKERS



- HIGHLY VISIBLE, NON INTRUSIVE, PERMANENTLY COLORED STAKES
- SUPREME DURABILITY AND RESILIENCE IN EXTREME TEMPERATURE CHANGES
 - THE **ONLY** FLEXIBLE DISTANCE MARKERS
- WITHSTAND CROSS CUT OR DIAGONAL MOWING IN **ANY** DIRECTION
 - SPEEDS UP GAME PLAY AND MOWING TIMES
 - EASY 2-STEP INSTALLATION
 - 6 MONTHS WARRANTY
- REPLACEMENT MARKERS AND INSTALLATION KIT ARE AVAILABLE



Step 1: Continue mowing without getting off to take out the markers.
Step 2: There is no step 2.



Recycled Plastic Rope Stakes and Markers

ColorFlex markers are an industry exclusive item that was designed to remove one of the most bothersome steps of maintaining the greens. Speed up your mowing times by simply mowing over them.

- Blue
- White
- Red
- Yellow
- Green
- Orange

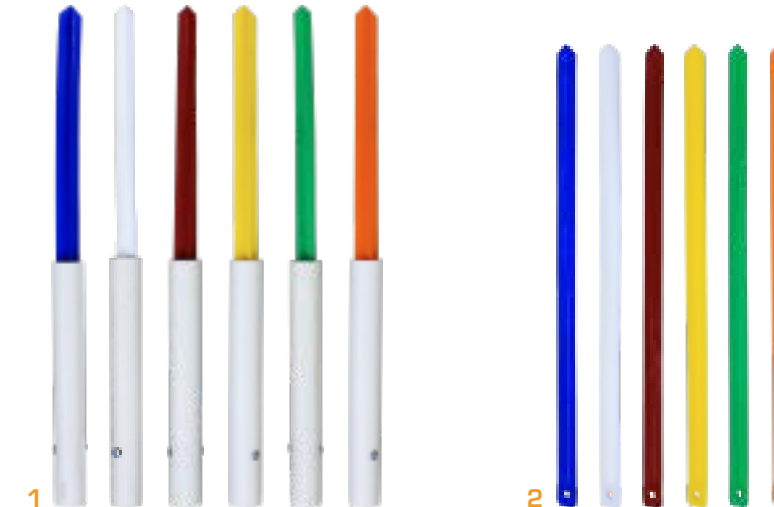

- 1. ColorFlex Distance Markers [No. 299]
- 2. Replacement Markers [No. 299-01]

Made of recycled plastic, these color impregnated markers and rope stakes are durable and highly visible - perfect for the fairway.

- Black
- Green
- Red
- White
- Blue

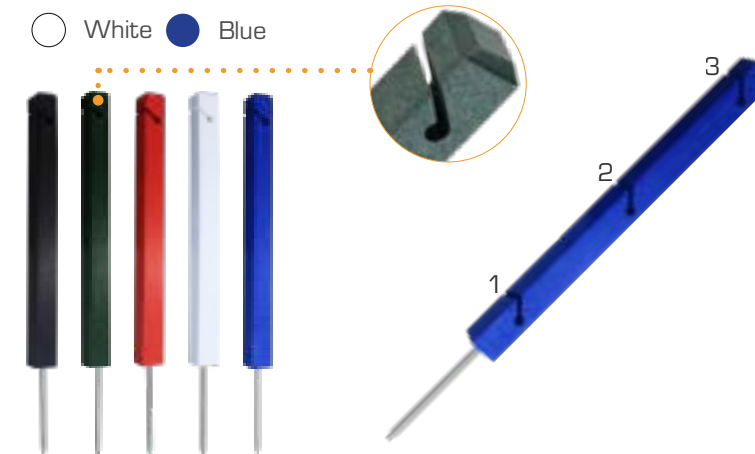

- Rope Stake [No. 289]
- 15" Rope Stake [No. 289-15]
- 18" Rope Stake [No. 289-18]
- 24" Rope Stake [No. 289-24]
- 30" Rope Stake [No. 289-30]
- 36" Rope Stake [No. 289-36]

- Custom Rope Stake [No. 289-CUSTOM]
- Step 1: Choose a color
- Step 2: Choose any length
- Step 3: Choose quantity of slots (1 is included)
- Step 4: Choose the location and side of slots

The kit includes everything you would need to install your ColorFlex markers quick and effortlessly. It includes a drill bit, a rubber mallet, and a PVC extension pipe. Sold separately, as well.



- Installation Kit [No. 299KIT]
- Rubber Mallet [No. 299MAL]
- Drill Bit [No. 299BIT]
- PVC Tube Extension [No. 299TUBE]

- Blue
- White
- Red

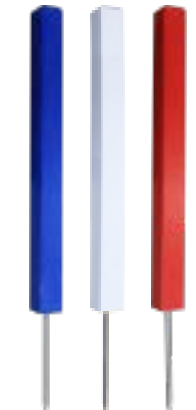

- Hazard Markers [No. 296]
- Size: 24"
- Appropriately color coded for OB (white), Lateral (red) & Water (blue) hazards to reference potential trouble areas on the course.

Fairway Markers and Rope

Made of heavy duty polymer, these domed distance markers come complete with a 6" stainless steel spike.



Domed Polymer Distance Marker [No. 571]

Cast aluminum distance marker with a powder coated finish. Comes complete with a 6" stainless steel spike.



Domed Aluminum Distance Marker [No. 573]

Maintenance free, UV resistant, plastic markers. Cross-shaped structure with beveled tip makes for easy installation & replacement.

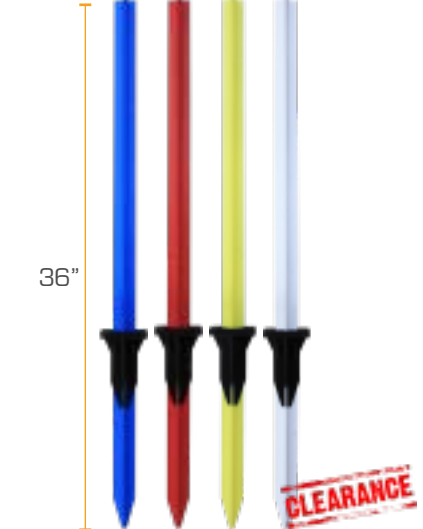
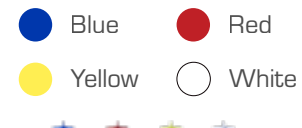

SMP Fairway Marker [No. 293]

Made of durable polypropylene material, this braided rope is 1/4" in diameter is waterproof and resists rot, oil and other chemicals.



Three Strand Braided Rope
Available length: 1000 ft spools [No. 287]

Made of quality flexible material, it maintains elasticity even in the coldest climates. Elasticity prevents the pulling out of the stakes if encountered. The rope remains taut and will not sag.

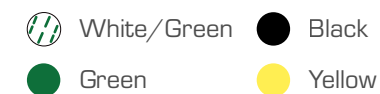

Bungee Rope
Available lengths: 250 ft and 500 ft
250 ft spool [No. 400-250]
500 ft spool [No. 400-500]

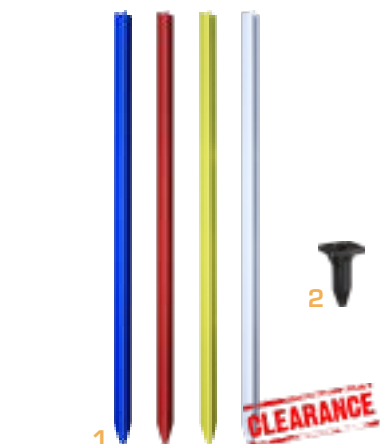

SMP Replacements
1. Replacement Stakes [No. 293-01]
2. Replacement Base [No. 293-02]

Marking Paint and Tools

No more bending, simply insert the turf paint in the wand, point towards the ground and start walking. The wheel on the bottom allows for smooth glide without stopping or jerking. Applying straight lines has never been easier!



Marking Wand [No. 268]

A handheld alternative to the marking wand. Makes marking easier and keeps hands clean of paint. Perfect for out of reach areas.

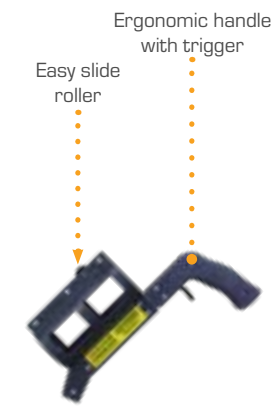

Marking Pistol [No. 269]

Mark hazards, out-of-bounds lines & grounds repairs with a bright and vivid, fast drying solution. A hole-in-one for coverage, value, and performance!



Rust-Oleum Precision Line Marking Paint [No. 271]
Sold in cases of 12. Other colors are available upon request.

WE GO THE DISTANCE

129'-222' BRAND 1
279'-442' BRAND 2
436'-530' BRAND 3

590'-765' RUST-OLEUM

TRUSTED QUALITY SINCE 1921
RUST-OLEUM
INDUSTRIAL BRANDS

Rust-Oleum Precision Line marking paint for easy-to-read, bright, vivid markings with no mess. Marks more linear feet than other brands.

AROUND THE GREEN



Scalloped Edge Hole Cutter
p. 22

Single Prong Cup Puller
p. 23

6" Aluminum Cup
p. 24

Cup Setter
p. 25

Hole-in-White Paint
p. 23

Hole-in-White Paint Tool
p. 23

Custom Flag
p. 30

Tournament Flag Poles
p. 27

PG	ITEM
22	Hole Cutters and Accessories
23	Cup Pullers
23	Hole-in Paint Tools
23	Hole-in Paint
23	Trimming Scissors
24	Greens and Practice Greens Cups
25	Cup Liners
25	Cup Setters
25	Cup Covers
25	NEW! Mully Cup Lifter
26	Regulation Flag Poles
26	Ferrules
27	Tournament Poles
28	Bayco Guard for Flag Poles
28	Reflectors
28	Smart Stick Poles
29	Greens Flags and Accessories
30	Custom Flags
32	Sand Trap Rakes and Guards
33	Coco Drag Mats
33	Dew Whipping Poles
33	Greens Speedmeters
33	Divot Repair Tool



Hole Cutter and Accessories

The hole cutters are primarily made of aluminum alloy, making them durable and strong but light. They each come with either scalloped or straight blade.



1. Lever Style Hole Cutter (scalloped) [No. 222]
Lever Style Hole Cutter (straight) [No. 223]
 Easy to use lever makes for a quick hole extraction.

2. Foot Extraction Hole Cutter (straight) [No. 224]
Foot Extraction Hole Cutter (scalloped) [No. 225]
 A classic hole cutter with shoe platforms on either side and a fixated handle.

Heat treated cutting blades ensure a clean cut hole. Available as scalloped and straight blade with an inside edge (for sandy and USGA soil) or an outside edge (for push-up greens and native soil).

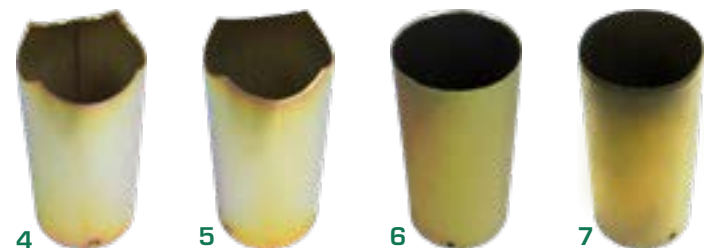

4. Inside Edge Scalloped Blade [No. 220-IN]
5. Outside Edge Scalloped Blade [No. 220-OUT]
6. Inside Edge Straight Blade [No. 221-IN]
7. Outside Edge Straight Blade [No. 221-OUT]

Wider hole cutter that cuts a 6" wide hole. Perfect for the Temporary Cup No. 256



3. Wide Hole Cutter [No. 219]
 A hole cutter for 6" wide temporary cup for special events.

HOLE CUTTER ACCESSORIES



8. Hole Cutter Flanged Stop [No. 217]
 Adjustable flanged stop ensures proper hole depth every time.

9. Black Hole Cutter Guide [No. 230]
 Cast aluminum and powder coated red. This guide prevents scuffs and marks on the greens made by the operator.

Hole-In Paint & Tools; Cup Pullers; Trimmers

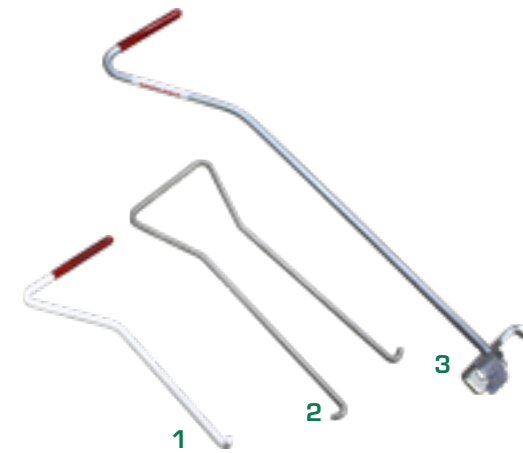

Cup Pullers

- 1. Single Pronged Cup Puller [No. 210]**
 Powder coated white with a red rubber handle.
 Size: approx. 6"
 Works on all cups.
- 2. Double Pronged Cup Puller [No. 206]**
 Aluminum; Pinch and release, then pull out the cup.
 Size: approx. 8"
 Works on all cups.
- 3. Three Pronged Cup Puller [No. 200]**
 Zinc plated steel with a red rubber handle; Place, twist and pull to remove the cup.
 Size: approx. 24"
 Works only on 250AL cups.



Hole-In Paint Tools

- 4. Aluminum Paint Tool [No. TL1]**
- 5. Cup Protector* [No. CP1]**
 Easy to use guide to paint the top of the hole while protecting the grass around the upper edge and the cup from the spray of the paint.
 *Cup protector available in every case of Hole-In-White paint and sold separately, as well.

- Hole-In Paint Applicator [No. 207]**
No cup protector required.
 Paint a perfect 1" depth circle above the cup while protecting the cup and grass around the hole, leaving a crisp, sharp edge.

HOLE-IN PAINT

Superior quality scissors, constructed from forged Stainless Steel. Comes complete with a dedicated plastic carry wallet. The curved design makes it easier to neaten the edges of freshly cut holes.

Hole-In paint is a whitener specifically formulated to last a long time and is not harmful to the soil or turf. One spray can could yield approximately 80 holes. It makes the top of the hole bright and visible from afar; speeding up play time in the process. Approved by PGA, Champions, and the LPGA, use this tournament grade standard to upgrade your course.



Curved Trimming Scissors [No. 211]



- 6. Hole-In-White [No. PT1]**
 Comes in a box of 12 cans (12 oz each)
- 7. Hole-In-Pink [No. PT2]**
 Comes in a box of 6 cans (12 oz each)

Greens Cups

PRO-HOLE CUPS

Pro Hole Cups are designed and finished to precise standards, resulting in a world class greens cup. Completed with locking ferrule system that ensures unnecessary premature wear of the flag pole ferrule.



Aluminum Pro Hole Cup [No. 253AL]

This cup is made of durable heat treated aluminum alloy

ALUMINUM CUPS

These cups are die cast oversize, then machined down to precise dimensions to minimize wobble in the hole. The aluminum cups are anodized then powder coated a bright white for best corrosion protection. Meets all USGA requirements.



1. Aluminum Greens Cup (4.25") [No. 252AL]

2. Aluminum Green Cup (6") [No. 250AL]

3. Temporary Aluminum Greens Cup [No. 256]

6" deep and 6" wide temporary cup for special events.

4. PGA Greens Cup [No. 250PGA]

Precision machined to exact PGA tolerance inside and out. The base is designed with three support pads to maintain a stable height.

PLASTIC CUPS

Made of durable, chemical resistant polymer material and meets all USGA regulations. Perfect for putting greens.



6" Plastic Pro Hole Cup [No. 253PL]

This cup is made of hard plastic material.



4. Plastic Greens Cup (4.25") [No. 255 PL]

5. Plastic Greens Cup (6") [No. 250PL]

6. Plastic Cup with Bronze Insert (6") [No. 250PL/BZ]

Bronze bushing made of certified bearing bronze withstands abrasion and prevents sticking, extending the life of your cup.

Cup Setters , Covers, & Liners; Mully Cup

Cover the putting green holes with this easy to install and remove cover. Made of durable plastic, it withstands pressure and weight.



Plastic Cup Cover [No. 262]

Cast aluminum cup setter consistently places cups at the correct depth, minimizing damage to the rims of aluminum cups and preventing ball interference.



Aluminum Cup Setter [No. 205]

Completely flexible, stain resistant plastic golf ball tender. Simply place it onto the flag pole, no need to remove the ferrule. It allows the golfer to lift the ball by lifting the flag pole, reducing bending. Sold in sets of 18 or individually.



NEW! Golf Ball Tender [No. 309]

SpeedWrap liners are thin, flat inserts that fit only in our pro hole cups. Fully customizable with a club logo or sponsor for increased revenue. The blank and specialized cup liners are in stock and ready for immediate shipping.



SpeedWrap Liners [No. 253]

Blank Cup Liner [No. 253L-4 or 253L-3]

Customize Your Liner [No. 253CUSTOM]

Sold in two versions, V3 fits the older cup design as well as 253PL, where as V4 is for the new design of 253AL.



Bayco Golf introducing: Mully Cup Lifter - an easy to install, no-bend ball lifter with zero golfer-pole contact and easy ball retrieval. Simply install the two halves around your flag pole and slide it into the cup - **no need to remove the ferrule!** 360° ball entrance with no interference.

- Fits regulation (1/2") and tournament (3/4") poles.
- Made of durable plastic.
- Includes all necessary hardware.

NEW! Mully Cup Lifter [No. 319-01]

Regulation Poles (1/2")

Regulation Flag Poles [No. 300]

Bayco Golf regulation fiberglass poles are manufactured to the highest quality and appearance for excellent corrosion and weather ability. The regulation poles are 1/2" thick and come in variety of sizes and colors/stripes. They are veil wrapped to increase lifespan and reduce splinters from fiberglass material.

Every flag pole is top threaded and color impregnated throughout which means that the color will not peel off or fade with time.

The flag poles are completed with a smooth ferrule (you may replace it with a slotted [308STD] or locking [308B*] ferrule), and with a top acorn nut that will suit the swivel for grommet style flags or tube style flags.

When shipped, we add a sleeve on bushing and ferrule for additional protection.

*Locking ferrule only works with Pro Hole cups

Ferrules



Flag pole holder mounts directly to your choice of surface. Holds 1/2" poles only. Available as a kit with an American or a Canadian flag.

Kit includes a holder, a flag, an acorn nut, and a 3' white regulation pole. No ferrule required.

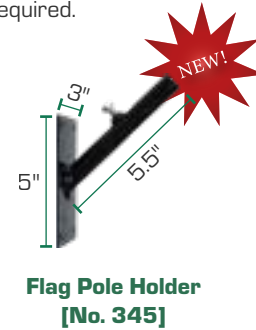

Available Colors and Striping

	5'	7'	7.5'	8'
White Pole	300W-5	300W-7	300W-75	300W-8
Yellow Pole	300Y-5	300Y-7	300Y-75	300Y-8
White Pole with 1 Black Stripe	-	300BW-71	300BW-751	300BW-81
Yellow Pole with 1 Black Stripe	-	300YB-71	300YB-751	300YB-81
White Pole with 2 Black Stripes	-	-	300BW-752	-
Yellow Pole with 2 Black Stripes	-	-	300YB-752	-
White Pole with 2 Red Stripes	-	-	300RW-752	-
White Pole with 2 Blue Stripes	-	-	300BLW-752	-
White Pole with 2 Pink Stripes	-	-	300PW-752	-
White Pole with 2 Green Stripes	-	-	300GW-752	-

** All other poles discontinued. Please see Clearance for available stock.

Tournament Poles (3/4")

Tournament Flag Poles [No. 300T]

Bayco Golf tournament fiberglass poles are manufactured to the same standards as the regulation poles. They are 3/4" thick in the middle and are tapered, making them stronger and more wind resilient. They also come in variety of sizes and colors/stripes and can reach up to 10' in length.

Like the regulation poles, the tournament poles are veil wrapped, top threaded and color impregnated ensuring their longevity.

The flag poles are completed with a smooth ferrule (you may replace it with a slotted [308STD] or locking [308B*] ferrule), and with a top acorn nut that will suit the swivel for grommet style flags or tube style flags.

When shipped, we add a sleeve on bushing and ferrule for additional protection.



p. 29
Quick Click [No. 316PL]

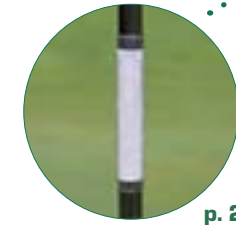

p. 28
DIY Laser Reflector [No. 3000-9]

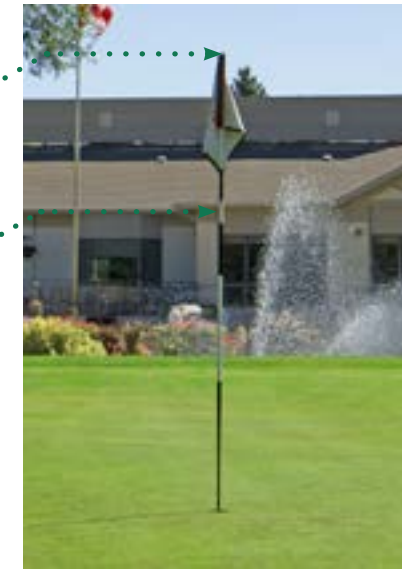

Available Colors and Striping

7'	7.5'	8'	10'	
300TW-7	300TW-75	300TW-8	300TW-10	White Pole
300TY-7	300TY-75	300TY-8	300TY-10	Yellow Pole
300TBW-71	300TBW-751	300TBW-81	-	White Pole with 1 Black Stripe
300TBY-71	300TBY-751	300TBY-81	-	Yellow Pole with 1 Black Stripe
-	300TBW-752	-	-	White Pole with 2 Black Stripes
-	300TBY-752	-	-	Yellow Pole with 2 Black Stripes
-	300TRW-752	-	-	White Pole with 2 Red Stripes
-	300TLW-752	-	-	White Pole with 2 Blue Stripes
-	300TPW-752	-	-	White Pole with 2 Pink Stripes
-	300TGW-752	-	-	White Pole with 2 Green Stripes

** All other poles discontinued. Please see Clearance for available stock.

An economical and easy way to re-new and protect splintered, cracked, faded, scratched, or dirty poles. Quickly applies with heat gun and will last for years. Fits tournament and regulation poles.



Bayco Guard for Flag Poles
250' Roll for 1/2" Pole [No. 3112]
250' Roll for 3/4" Pole [No. 3134]

Easy to screw on top of any flag stick. Made with brass bushing to avoid premature wear of the threads. Sold individually.



4. Five Eyed Smarty Reflector [No. 304-5B]
5. Six Eyed Smarty Reflector [No. 304-6B]

Easy to screw on top of any flag stick. Made of specially formulated, soft polyurethane cylinder protects greens from flag swivel denting when dropped. Sold individually.



Elite Laser Reflector [No. 303-ELITE]

Full 360° visibility, no dead spots, made of highly reflective material with a large surface area. Made for both regulation and tournament poles. Sold individually or in sets of 9.



Bayco Laser Reflectors
1/2" Opening [No. 3012]
Set of 9 [No. 3012-9]
1/4" Opening [No. 3034]
Set of 9 [No. 3034-9]

Make your own laser reflectors! Easy to install on your existing flag poles by heat shrinking the plastic provided on top of the reflector. It fits any pole of 1" or less in diameter. Sold only in sets of 9.



DIY Laser Reflector [No. 3000-9]

Six eye prism flag sticks bring 100% reflection coverage making those poles hotter, faster, and more accurate for all range finders.



Smart Stick Poles
Regulatory Smart Stick [No. SS300]
Tournament Smart Stick [No. SS300T]
Sizes: 7', 7.5', 8'
Contact us for custom striping.

FLAG ACCESSORIES



- 1. Quick Click [No. 316PL]**
Removes the need for tools to change the flags. Works only with Bayco Tube Flags. Available as set of 9 [No. 316PL-9]
- 2. Security Nut [No. 1005NUT]**
Secures flags onto flag poles and prevents theft. Slim enough to be used with or without the Acorn Nut.
- 3. Acorn Nut [No. 1005-3BK]**

All of our course flags are made of durable, quality, 400 Denier Solar Max material complete with a tube locking attachment.

- *Custom colors available.
- Blue Red Green
 - Yellow White Orange
 - Black Pink Purple

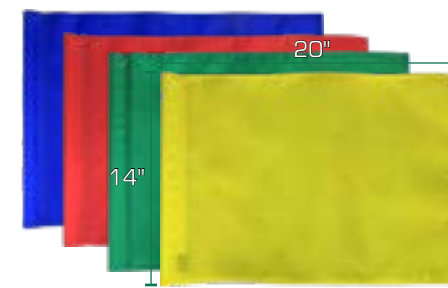

14x20" Tube Flag [No. 1005]

All of our specialty flags are made of Double Sided Poplin material. It is dye sublimated for added durability, making them less vulnerable to fading and eliminating peeling. They come complete with a tube locking attachment.



14x20" Country Tube Flags
American Flag [No. 1005AMERT]
Canadian Flag [No. 1005CANT]



14x20" Special Event Tube Flags
Awareness Flag [No. 1005AWAT]
Revenge Flag [No. 1005REVT]

All of our checkered and numbered flags are made of dye sublimated material for added durability, making them less vulnerable to fading and eliminating peeling. They come complete with a tube locking attachment.

- *Custom colors available.
- Blue Red
 - Green Yellow
 - White/Black
 - Green Yellow White

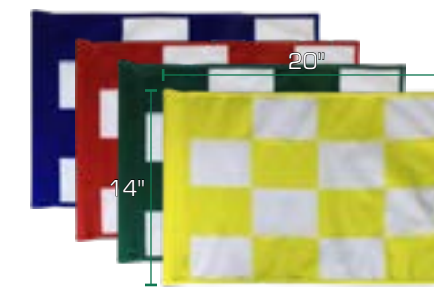

14x20" Checkered Tube Flag [No. 1005CHT]



14x20" Numbered Tube Flag [No. 1007_1-9T or 10-18T]
Sold only in sets of 1-9 or 10-18.

Custom Flags

ANY COLOR COMBINATION



If you can think it, we can print it! We can help you choose the colors that compliment your logo best, or if you already have a color in mind and/or know the color code (HEX, RGB, CYMK) we can match it. We can even change the colors of your logo!*

ANY LAYOUT

Whether you need a border or not, numbers or text, or simply your logo** on the flags - we can do it! If you have a custom graphic that you want displayed on your flag, or you'd like to show off your sponsors - we are here for you! If you have a new feature and would like to advertise or you want to honor someone special - it's all possible with Bayco Custom Golf Flags!

UNLIMITED CHOICE - ONE PRICE

We offer several different sizes of custom golf flags, of which 14"x20" and 6"x8" are most common. We also provide three different shapes - rectangle, burgee, and pennant. You can order them double sided (DS) or single sided (SS). Our prices for each flag type/size are the same no matter what colors or layout you choose. There are no set up fees for proofs and you can make changes until you are satisfied with the result! Don't be afraid to get creative, **your only limit is your imagination!**

*Logos must be high resolution and be either a PDF or a vector file (.ai or .eps)

** Any graphics or logos must be obtained legally and have all the required permissions to be used in your custom flag design. Bayco Golf is not responsible for any lawsuit related to the distribution of illegally obtained content.

CALL 1 (877) 668-4653 OR YOUR NEAREST BAYCO DISTRIBUTOR TO ORDER YOURS TODAY.

Possibilities are endless!

“SIMPLY - THE FINEST QUALITY CUSTOM GOLF COURSE FLAGS

Frequently Asked Questions:

What is Dye Sublimation Printing?

Dye Sublimation is a printing process which reproduces graphics and images into various flexible and rigid substrates - in our case, fabric. Using a combination of high heat and pressure, solid dyes are absorbed directly into the fabric, creating many advantages over traditional screen-printed graphics.

How are our flags made?

Once a design is approved, the graphic files are fitted onto a template using Illustrator. Those files are printed and then sublimated into the fabric. The fabric portion with dye is cut out and passed on to our sewing and finishing department. After finishing, the products are cleaned, checked and are packaged for shipping.

What format should your artwork be in?

Please ensure that your artwork files are of good quality, preferably vector (.ai or .eps). Raster images, such as JPEG and PNG can be submitted but extra charges may apply should we need to re-draw them in a vector format. If you are unsure of what files you currently have, please contact us and we can assess them for you.

How long does it take for flags to be completed?

Once we send you the proofs and they are approved by you, it typically takes 2-3 weeks for them to be printed (on a first come, first serve basis). Shipping (depending on location) can take additional 3-7 business days in North America. Please contact us for a more accurate timeline for your specific project.

What fabric choices do you offer?

- **Poplin Flags** - Our poplin flags are great for heavy graphics and double sided flags because it uses an optional blocker to prevent see-through from front to back.
Note: It is the heaviest option especially if the blocker is added. This fabric needs wind to move.
- **Dura Flags** - Very stable fabric that is porous and allows wind to move through it. It has 95% transparency which makes it perfect for single sided flags.
- **Poly Silk Flutter** - This fabric is recommended for events as it flutters even in low breeze settings. It has 98% transparency and is very lightweight, perfect for single sided flags.

How is vector different than raster?

Simply put, raster images are created by pixels and their quality depends on the DPI (dots per inch) or PPI (pixels per inch). The lower the DPI, the more "pixelated" it looks. Raster image files include .jpeg, .png, and .tiff formats.

Vector images are made up of paths with mathematical formulas telling the path what color or shape it needs to be. Thus, vector images retain their appearance regardless of size and can be scaled infinitely. Although vector files are rarely used for photographs or paintings, they are perfect for designs such as logos and illustrations. Vector files include .ai, .eps, and .dmg formats.



Sand Trap Rakes & Parts; Handle Guards

RAKE HEADS

Our rake heads are made of durable, lightweight plastic that is easy to use and carry. They spread sand evenly, leaving a consistent playing surface with minimal difference in grooves.



Lightweight Rake Head

Available in 21" [No. 102] and 15" [No. 105]

Octagon Rake Head

Available in 21" [No. 164BK] and 15" [No. 151BK]

Disc Tooth Rake Head

Available only in 16" [No. 161]

RAKE HANDLES



Yellow Wood Handle

Available only in 48" [No. 106]



Green Fiberglass Handle

Available in 51" [No. 154] and in 72" [No. 152G-72]



Yellow Fiberglass Handle

Available in 51" [No. 152] and in 72" [No. 152Y-72]



Brown Fiberglass Handle*

Available in 51" [No. 154BR] and in 72" [No. 152BR-72]



Green Cart Fiberglass Handle**

Available only in 42" [No. 155]



Black Guard comes only in a 125' roll

Guard for Rake Handles

Quickly renew your rake handles by applying the guard with a heat gun. **125' Roll [No. 140-125]**
250' Roll [No. 140-250]

COMPLETE UNITS

Lightweight Rake	15" Head	21" Head
48" Wooden Handle	100PO	125YE
51" Green Fiberglass Handle	118G	125G
51" Yellow Fiberglass Handle	118YE	126YE
51" Brown Fiberglass Handle	118BR	125BR

Octagon Rake	15" Head	21" Head
51" Green Fiberglass Handle	150GR	166GR
51" Yellow Fiberglass Handle	150YE	166
51" Brown Fiberglass Handle	150BR	166BR
72" Green Fiberglass Handle	150-72G	165GR
72" Yellow Fiberglass Handle	150YE/72	165
72" Brown Fiberglass Handle	150BR/72	165BR
42" Green FG Cart Handle	150GR/CART	166

Disc Tooth Rake	16" Head
51" Green Fiberglass Handle	160GR
51" Yellow Fiberglass Handle	160YE
51" Brown Fiberglass Handle	160BR
72" Green Fiberglass Handle	160GR/72
72" Yellow Fiberglass Handle	160YE/72
72" Brown Fiberglass Handle	160BR/72
42" Green FG Cart Handle	160GR/CART

* While quantities last.
** Other colors and sizes are available upon request.

Coco Mats and Other Greens Tools

Made of natural fiber that will not damage, burn, or bruise tender grass. The fibers offer superb broom action, making it perfect for top dressing and filling aerated holes. Complete with a tow bar and a chain for easy attachment.



Bayco Golf Coco Drag Mats

6' x 4' Coco Mat [No. 247-6x4]
6' x 5' Coco Mat [No. 247-6x5]
6' x 6' Coco Mat [No. 247-6x6]

Removes dew and other light debris from greens. The tip (8") slides inside the handle (8") during storage and transportation.

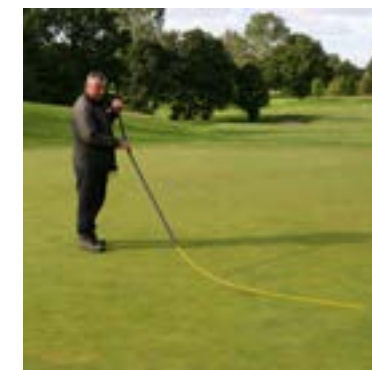

Dew Whipping Pole

Complete Unit [No. 280]
Replacement Rod [No. 280-2A]

Made of extruded aluminum alloy with a V-shaped groove extending along its length and a milled base to reduce bounce as the ball makes contact with the green surface.
Length: 36"

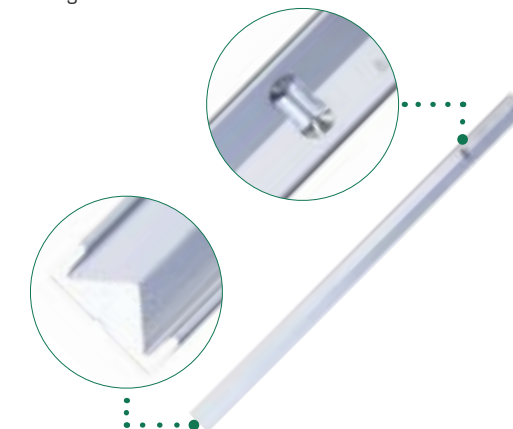

Greens Speedmeter [No. 240]

New and improved ball mark repair tool. No moving parts, one solid piece of aluminum with six blades forces grass and roots into damaged areas. Cap included.
Length: 36"



InstaFix [No. 227-36]



Bronze Tee Sign
p. 37

PG	ITEM
36	Heavy Duty Metal Signs
36	Recycled Plastic Easels
36	Fairway Markers
37	Aluminum Signs
37	Bronze and Aluminum Tee Signs
37	Aluminum Directional Signs
37	Recycled Plastic Tee Signs



Steel Signs, Easels, & Fairway Markers

Our Heavy Duty Metal Signs are produced from a single piece of 3mm metal with a powder coated finish. They come available with single double spikes and single or double sided. We have these signs with stock messages or we can design a custom message with your course logo. All messages are applied to signs using a pressure sensitive label, so the possibilities are virtually endless!

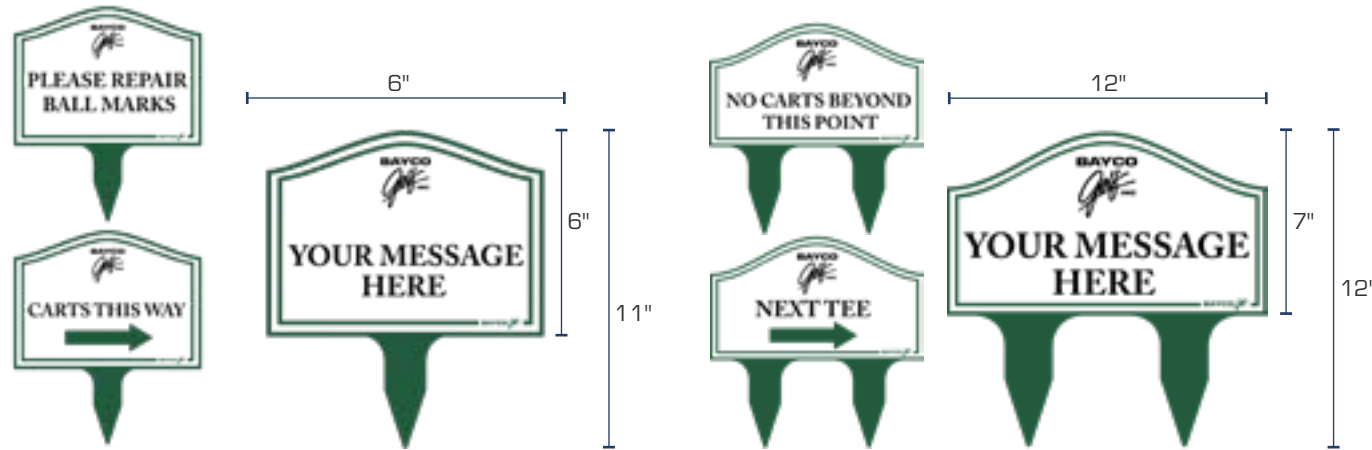

6"x6" Heavy Duty Steel Signs [No. 591]

AVAILABLE STOCK MESSAGES:

- DROP AREA
- PLEASE REPAIR BALL MARKS
- PLEASE REPLACE DIVOTS
- CARTS THIS WAY →
- CARTS THIS WAY ←
- NEXT TEE ←
- NEXT TEE →
- NO CARTS BEYOND THIS POINT
- KEEP CARTS 30 FT FROM GREENS
- KEEP CARTS OFF APRON

6"x12" Heavy Duty Steel Signs [No. 592]

CUSTOMIZE YOUR OWN SIGN:

1. Choose your sign size: 6"x6" (single spike)
6"x12" (double spike)
2. Choose whether you want your sign single or double sided.
- You may have the same message on both sides or different messages on either side.
3. Choose your message and design. You may have a simple message, or we can add your logo and other design elements. Please contact us for more information.

Made from the same great recycled plastic you've come to know and love from Bayco Golf products. Easily display important information for your golfers such as the golf time or the daily yardage.



Recycled Plastic Custom Easels

Standard yardage markers come in Bronze or Aluminum. Choose from 4 shapes (rectangle, square, oval or circle), sizes are made to order. Each can be customized with nearly any information including custom logo.



Fairway and Distance Markers

CUSTOMIZE YOUR OWN SIGN:

1. Choose your material (Bronze or Aluminum)
2. Choose your shape (rectangle, square, oval or circle)
3. Pick your size

Aluminum, Directional & Tee Signs

Aluminum Signs are produced from a single piece of 3mm metal with a powder coat finish.

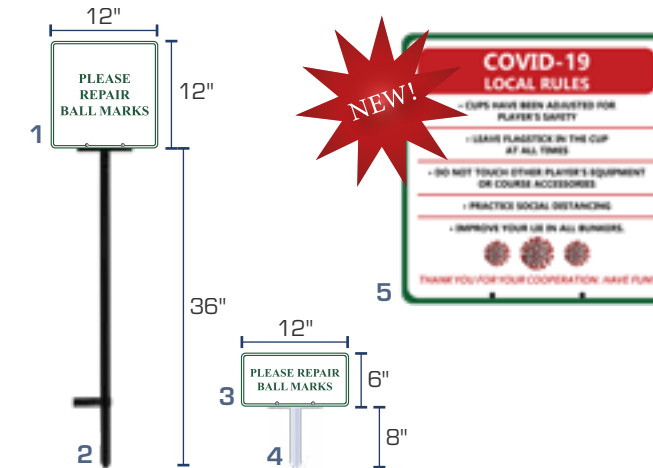

Customizable Aluminum Signs with Spikes

1. 12"x12" Aluminum Sign [No. 500]
2. 36" Aluminum Spike - Black [No. 529]; White [No. 529W]
3. 6"x12" Aluminum Sign [No. 528]
4. 8" Aluminum Spike - Black [No. 500-1BK]; White [No. 500-1]
5. Covid-19 Rules [No. 500-19]

NOTE: Signs and spikes sold separately.

AVAILABLE STOCK MESSAGES:

- NO CARTS BEYOND HERE
- CARTS IN ROUGH ONLY
- CHEMICALS APPLIED TODAY
- NO CARTS TODAY
- PLEASE REPAIR BALL MARKS
- GROUND UNDER REPAIR
- COVID-19 RULES

Made from high quality steel, with a powder coated finish and white lettering. This new design makes this sign one complete piece, eliminating the need for spikes.



Aluminum Directional Signs

AVAILABLE STOCK MESSAGES:	GREEN	BLACK
PLAIN ARROW	540	540BK
NEXT TEE	541	541BK
CARTS	542	542BK
GOLF CARTS	543	543BK
10 TEE	544	544BK
NO CARTS	545	545BK

Choose from the shapes shown or let us create a design unique to your course. We will provide proofs of each sign for your approval. Provide us with the information needed for each sign and we will do the rest. Multiple mounting options are available.

Available Shapes:



Bronze and Aluminum Tee Signs

CUSTOMIZE YOUR OWN SIGN:

1. Choose your material (Bronze or Aluminum)
2. Choose your shape
3. Pick your size

With recycled plastic signs the design possibilities are virtually endless. Our plastic signage is a very classy yet an economical way to add first class signage to your facility.

Available Shapes:



Recycled Plastic Tee Signs

The inset method allows for the design to 'pop out' from the base. Your design is printed and inset into the sign, then covered with a protective shield and sealed with clear resin.

The engraved method allows for the design to be 'sunk' into the base. Your design is precisely engraved into the sign base, leaving it blank. You may choose to have it filled with our special resin.



E-Z Reacher
p. 41

PG	ITEM
40	Soil Samplers
40	Aerifiers
41	Sprinkler Head Trimmers
41	E-Z Reachers
41	Backpack Sprayers
41	Aluminum Landscaper Rakes
41	Roller Squeegees
41	Plug Pushers



Soil Samplers & Aerators

Soil samplers allow core samples to be taken for evaluation of soil composition and root growth or for subsequent soil analysis. It also helps determine the need for aeration and to select the proper fertilizer for root development.

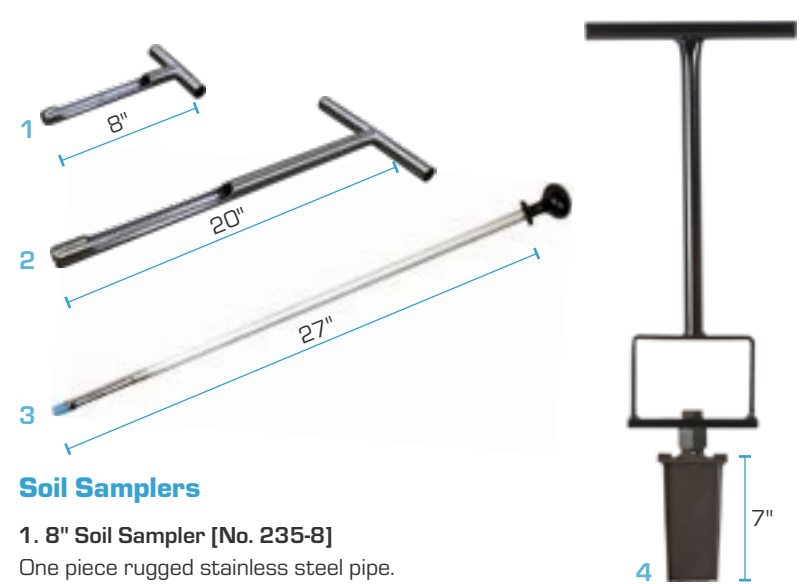

Soil Samplers

- 1. 8" Soil Sampler [No. 235-8]**
One piece rugged stainless steel pipe.
- 2. 20" Soil Sampler [No. 235]**
One piece rugged stainless steel pipe.
- 3. 27" Greens Probe Soil Sampler [No. 237]**
Less intrusive, one piece rugged stainless steel pipe. Complete with a rubber handle for added comfort.
- 4. Greens Section Soil Sampler [No. 238]**
This spade-like greens section soil sampler is tapered to give a clean cut and minimize surface disruption. The blade is then easily removed to examine the profile of the sample.

Why aeration is important?

Aeration is an essential practice that improves the long-term health and playability of golf courses. By using hollow tines to extract plugs, you can:

- Ensure longevity of your course
- Alleviate compaction
- Remove layering

Long lasting benefits of aeration:

The following benefits can be observed when aeration is done seasonally and correctly:

- Improves Water Infiltration
- Oxygenates the Soil
- Removes Thatch
- Encourages Root Growth
- Stimulates Microbial Activity
- Promotes Recovery from Stress

Made of heavy duty steel, these aerators are easy to use on those small and hard to reach spots on the greens that need immediate attention.

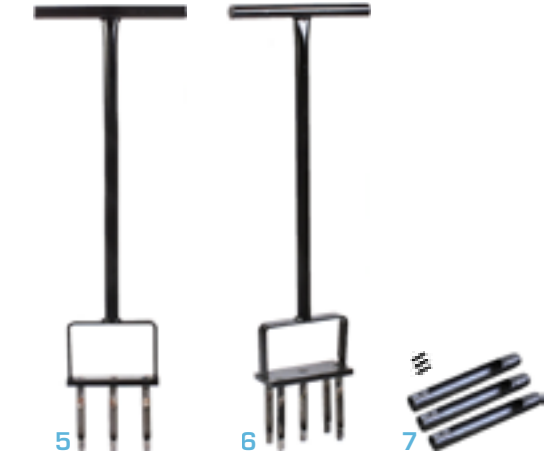

Aerifiers

- 5. Hand Operated 3-Pronged Aerifier [No. 236]**
- 6. Hand Operated 5-Pronged Aerifier [No. 239]**
- 7. Replacement Steel Tines [No. 236-1]**
Fits our aerifiers. Sold in sets of three. Complete with golding pins.

Other Essential Course Tools

Sprinkler heads can easily become lost on the course which can lead to negative impacts on the functionality of the irrigation system. These trimmers are easy to use and leave a clean edge around the sprinklers.

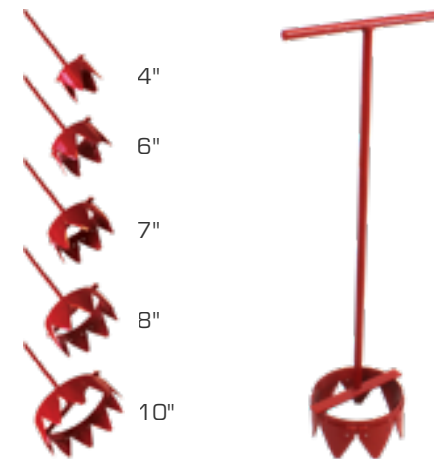

Sprinkler Head Trimmers

- 4" Diameter [No. 208-04]
- 6" Diameter [No. 208-06]
- 7" Diameter [No. 208-07]
- 8" Diameter [No. 208-08]
- 10" Diameter [No. 208-10]

Aluminum shaft with stainless steel grabbers that open to a 4.5" width. Capable of lifting up to 6 lb and sensitive enough to pick up a dime.



E-Z Reacher

- 32" Handle [No. EZR3200]
- 40" Handle [No. EZR4000]
- 72" Handle [No. EZR7200]

Durable, dense polyethylene tank, easy to fill 4.25" opening, 28" wand, and chemically resistant seal. Capable of performing every spraying task.



SOLO Back Pack Sprayer [No. 190]

This aluminum landscape rake is used for ground raking, smoothing, leveling, spreading, seeding & leaf clean-up. The heavy duty brace is all one piece and is riveted to the rake head.

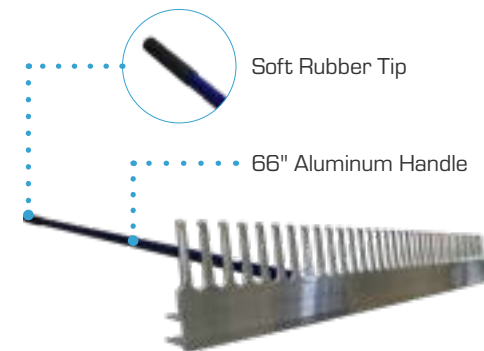

Aluminum Landscaper

- 24" Wide Rake [No. 114AL]
- 36" Wide Rake [No. 115AL]
- 48" Wide Rake [No. 116AL]

A squeegee roller made of industrial grade stainless steel axle and efficient non-absorbent rubber roller. It effectively rolls collected water off golf course greens and other surfaces. Replacement Heads Available.

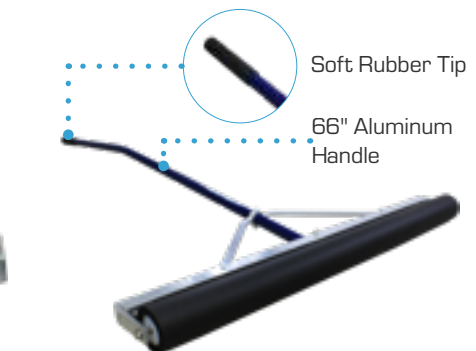

Roller Squeegee

	Complete Unit	Head Only
24" width	130-24	130-24H
36" width	130-36	130-36H
48" width	130-48	130-48H

Light, heavy duty aluminum plug pusher will make cleaning up the golf course easy. It efficiently pushes plugs or moves and levels sand and loose material.

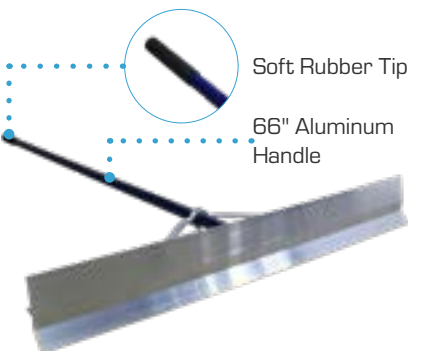

36" Plug Pusher [No. 131]

PRACTICE AREA

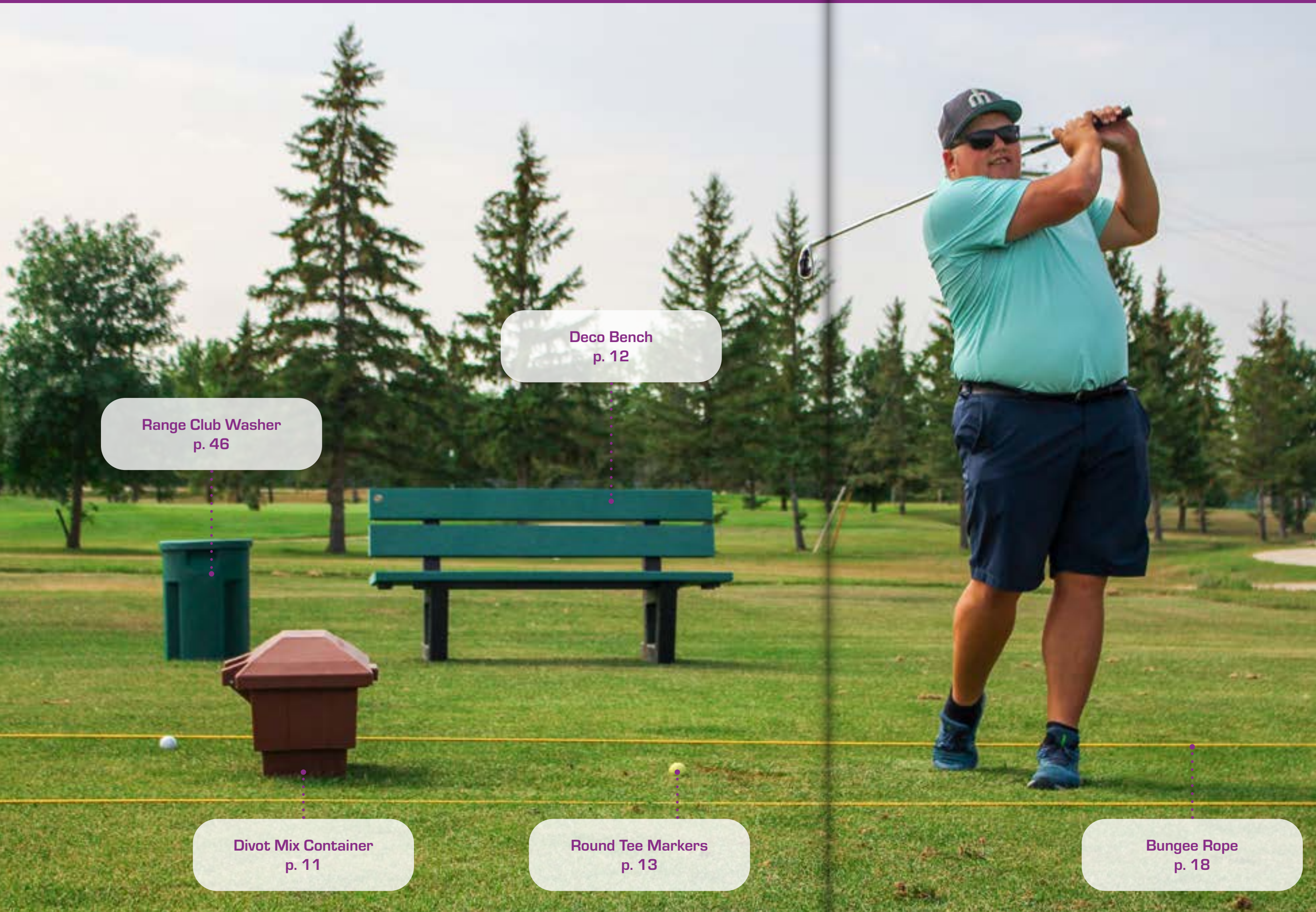

PG ITEM

- 44 Practice Greens Markers
- 44 Practice Greens Poles
- 45 Practice Greens Flags
- 45 Chipping Green Ball Pusher
- 46 Range Club Washer
- 46 Range Tube Flags
- 47 Range Banner



Deco Bench
p. 12

Range Club Washer
p. 46

Divot Mix Container
p. 11

Round Tee Markers
p. 13

Bungee Rope
p. 18

Practice Markers & Flag Poles

Made with 1/2" thick fiberglass rod and smooth, hard plastic head, with added option for a custom decal of your course logo.

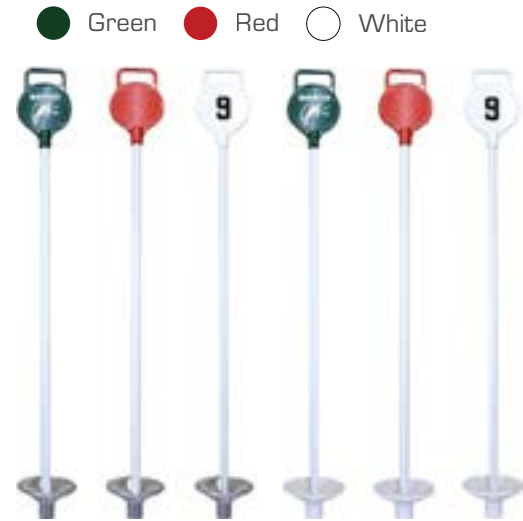

Gimme Practice Greens Markers

Decal:	Blank	Set of 1-9	Set of 10-18
Chrome Base	264/BLANK/CH	264/1-9/CH	264/10-18/CH
Plastic Base	264/BLANK	264/1-9	264/10-18

Made with 3/8" thick fiberglass rod and red powder coated aluminum round head. Available with white rod only.



Red Head Practice Greens Markers

Decal:	Blank	Set of 1-9	Set of 10-18
Plastic Base	274/BLANK/R	274/1-9R	274/10-18R
Target Base	267/BLANK/R		

*Target marker does not need a cup

Made with fiberglass rod, the poles come with plastic or chrome base. Available in Javelin tapered version, as well.



Practice Greens Poles

Rod Color:	1. White Rod	2. Yellow Rod	3. Javelin Rod
Chrome Base	272W/CH	272Y/CH	272J/CH
Plastic Base	272W	272Y	272J
Target Base	272WS	272YS	

Replacement chrome and plastic bases for your Bayco practice greens marker. Chromium on metal provides corrosion resistance and increases surface hardness. Plastic is a light and more economical alternative to the chrome base.



Practice Green Bases - Chrome and Plastic

Opening:	5/16"	3/8"	1/2"
Chrome Base	278-2CH	278-6CH	278-7CH
Plastic Base	P275-2	P275-3	P275-5

Practice Flags; Chipping Greens Ball Pusher

Our solid color flags are made of durable, quality, 400 Denier Solar Max material complete with a tube locking attachment.

*Custom colors available.

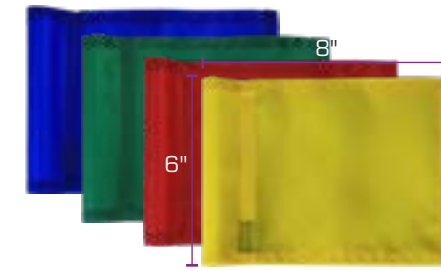
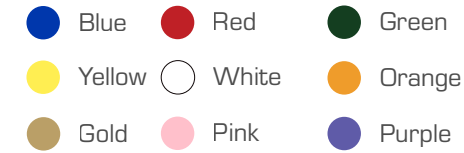

6x8" Solid Color Practice Greens Tube Flag [No. 273]

All of our checkered and numbered flags are made of dye sublimated material for added durability, making them less vulnerable to fading and eliminating peeling. They come complete with a tube locking attachment.

*Custom colors available.

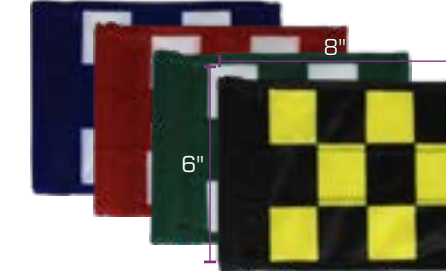

6x8" Checkered Practice Greens Tube Flag [No. 273CHT]



6x8" Numbered Tube Flag [No. 273N]

Sold only in sets of 1-9 or 10-18.

This easy to use ball pusher is perfect for the practice chipping green. It allows golfers to sweep balls quickly and effectively, speeding game time.



Chipping Greens Ball Pusher [No. 132]

All of our specialty flags are made of Double Sided Poplin material. It is dye sublimated for added durability, making them less vulnerable to fading and eliminating peeling. They come complete with a tube locking attachment.



6x8" Country Practice Greens Tube Flags

American Flag [No. 273AMER]

Canadian Flag [No. 273CAN]

Range Club Washer & Flags

Heavy-duty polyethylene body & cover. Holds two 12" x 12" bristle brushes that can be rotated for maximum utilization. Handles on either side for lifting & moving. Cover has 6" opening for easy access. No wires, clamps or screws required. Will not lift during use.



Black Range Club Washer [No. 695BK]



Green Range Club Washer [No. 695]

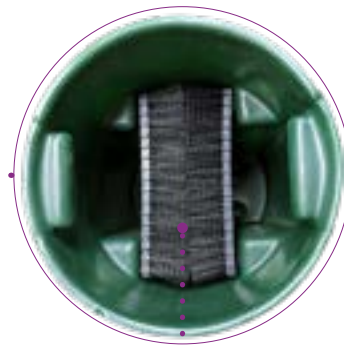

12" x 12" replacement brush for 695 Range Club Washer. Perfectly symmetrical on all sides allows for rotation and maximum utilization.



Club Washer Brush [No. 405]

Sold individually. Each club washer requires 2 brushes.

Our solid color flags are made of durable, quality, 400 Denier Solar Max material complete with a tube locking attachment.

- Blue ● Red ● Green
- Yellow White ● Orange
- Gold ● Magenta ● Purple

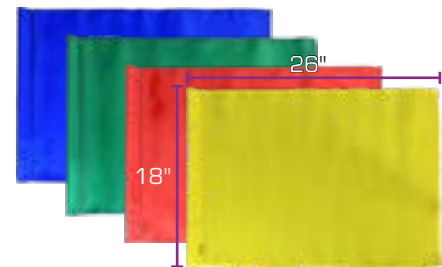

18x26" Solid Color Range Tube Flag* [No. 1009]

*Custom colors available

Our checkered flags are made of dye sublimated material for added durability, making them less vulnerable to fading and eliminating peeling.

- Yellow Green
- Red Blue

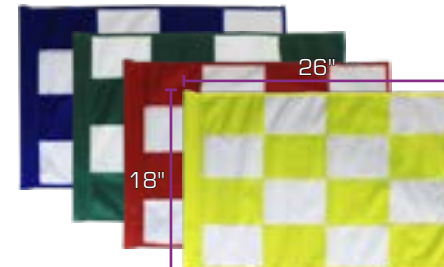

18x26" Checkered Range Tube Flag* [No. 1008CHT]

Range Banners



Range Banners made of heavy duty dye-sublimated (no peeling) polyester and durable PVC pipe. Available in a full unit, banner only, or framing kit only [No. RBKIT]. Numbered 50-300 in 25 yard increments. Some assemblance required.

YARDAGE	BANNER ONLY		COMPLETE UNIT	
	VERTICAL	HORIZONTAL	VERTICAL	HORIZONTAL
50 YDS	VRB050	RB050	COMVRB050	COMRB050
75 YDS	VRB075	RB075	COMVRB075	COMRB075
100 YDS	VRB100	RB100	COMVR100	COMRB100
125 YDS	VRB125	RB125	COMVR125	COMRB125
150 YDS	VRB150	RB150	COMVR150	COMRB150
175 YDS	VRB175	RB175	COMVR175	COMRB175
200 YDS	VRB200	RB200	COMVR200	COMRB200
225 YDS	VRB225	RB225	COMVR225	COMRB225
250 YDS	VRB250	RB250	COMVR250	COMRB250
275 YDS	VRB275	RB275	COMVR275	COMRB275
300 YDS	VRB300	RB300	COMVR300	COMRB300

Horizontal and Vertical Range Banners - Complete Units or Banners Only

PRO SHOP & CLUBHOUSE



Deco Bench
p. 12

Sand & Seed Bottle
p. 10

Double Brush Stand
p. 50

PG	ITEM
50	Spike Cleaner Stands
50	Replacement Brushes and Parts
51	Golf Bag Racks
51	Portable Outdoor Ashtrays
51	Eco-Blast Air Horns
51	Proximity Markers
51	E-Z Litter Stick



Spike Cleaner Stands & Brushes

Bayco Golf brush cleaner stands are constructed of 1" steel tubing with flange base. The base can be secured to a hard surface with lag bolts or onto grass or other ground surface with four 6" long spikes (all necessary hardware is provided).

Constructed to the same standards as 680 brush stand, this ensemble has the added support of two side brushes on either side of the brush stand for even better results.



Double Brush Spike Cleaner Stand [No. 680 or 680BK for black flange]



Double Brush Spike Cleaner Stand with Side Brushes [No. 687 or 687BK for black flange]

REPLACEMENT PARTS



- 1. Brush Assembly with Side Brushes [No. 606]
- 2. Black Brush Assembly with Side Brushes [No. 606BK]
- 3. Recycled Plastic Brush Assembly [No. E601]
- 4. Double Mount with Brush [No. 675] for ball washer ensemble
- 5. Single Mount with Brush [No. 670] for ball washer ensemble
- 6. Base Brush Assembly [No. 600] Holder Only [No. 605]
- 7. Black Base Brush Assembly [No. 600BK] Holder Only [No. 605BK]
- 8. Side Brush [No. 606-2]
- 9. Base Brush [No. 610]

Bag Racks, Ashtrays, & Other Related Items

Modular golf bag rack made of durable heavy duty metal with powder coated finish. They can be assembled to any length in multiples of 3', or be set back to back. Sold as a pack of two racks, holds up to 6 golf bags.

*All necessary hardware included



Golf Bag Racks [No. 780]

Collects unsightly cigarette butts and reduces fire hazard. Made of flame retardant, sturdy polyethylene. Won't rust, dent or crack. Simply lift off the lid to empty the large galvanized steel pail inside.



Portable Outdoor Ashtray

- Beige [No. 215BEIGE]
- Grey [No. 215GREY]

Liners [No. 215RL]

- Cease Fire Liners (Pack of 10)

Eco-Blast Air Horns are powerful, USGA approved sound emitters that can be recharged with almost any pump. They both emit approx. 115-120 dB.



Eco-Blast Air Horn

- 1. Hand Held Horn [No. 180]
- 2. Pro Horn [No. 180PRO]

Sturdy nickel plated metal frame complete with 25 cards (double sided). Refill cards are available in pack of 25.

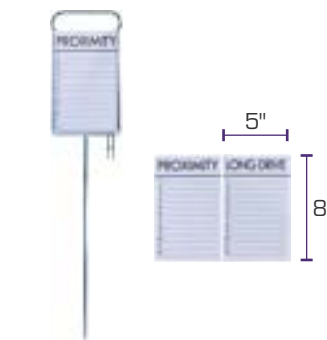

Proximity Markers

- Single Unit [No. 517]
- Pack of Four [No. 517-4]
- Replacement Pads [No. 517-2]

A 12 prong litter stick with a quick release trigger.

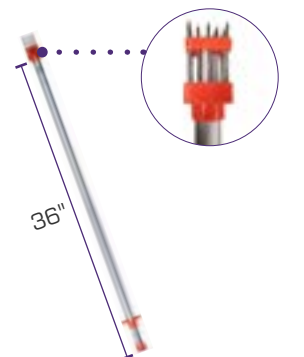

E-Z Litter Stick [No. EZL3612]

Take advantage of our clearance stock!

Over 24 Promotional Products

Brand new, reduced for quicker sale.

- Brand new flags, markers, poles and more!

- While quantities last. Hurry, we have limited stock!

PG ITEM

- 54 Practice Greens Flags
- 55 Greens Flags
- 56 SMP Fairway Markers
- 56 Placement Markers
- 56 Cube Tee Markers
- 56 Practice Greens Markers
- 56 Pro-Hole Plastic Cups
- 56 Customizable Solid Tee Markers
- 57 Poles



Clearance Practice Flags

Please contact us for the most up to date availability of clearance items.

Numbered course flags made from nylon material and screen printed numbers. Comes complete with tube lock attachment.



6"x8" Numbered Flags [No. 273]

Sold in sets of 10-18 only.

Colored Flags are made from 400 Denier Solar Max Material. Comes complete with tube lock attachment.



6"x8" Flags with Trim [No. 273-TRIM]



6"x8" Nylon Flags [No. 273]

Colored Flags are made from 400 Denier Solar Max Material. Comes complete with tube lock attachment.



Other 6"x8" Flags

Checkered [No. 273BU/BK-CHT]
Diagonal [No. 273R/W]

Placement Flags made from Nylon Material. Comes complete with attachment that goes in the middle of the flag pole. Fits both regulation and tournament poles.



4"x7" Vinyl Placement Flags

English [No. 327]
French [No. 327-FRENCH]

Placement Flags made from Nylon Material. Comes complete with attachment that goes in the middle of the flag pole. Fits both regulation and tournament poles.



4"x7" Nylon Placement Flags [No. 327]

Clearance Greens Flags

Colored Flags are made from 400 Denier Solar Max Material. Comes complete with tube lock attachment.



14"x20" Flag with Trim

Trim on Three Sides [No. 1010T]
Trim on All Sides [No. 1010TT]



14"x20" Open Center Checkered [No. 1006-CHT]



14"x20" Diagonal Flags [No. 1005]

Colored Flags are made from 400 Denier Solar Max Material. Comes complete with tube lock attachment.



14"x20" Four Checkered [No. 1221-CHT]

Venti Mesh flags are made from 100% Jersey-Like Polyester Material. Comes complete with tube lock attachment.



14"x20" Numbered Venti Mesh Flags [No. 1004]

Sold in sets of 1-9 and 10-18



14"x20" Venti Mesh Flags [No. 1004]

Clearance Markers and Cups

Maintenance free, UV resistant, plastic markers. Cross-shaped structure with beveled tip makes for easy installation & replacement.

- Blue ● Red
- Yellow White

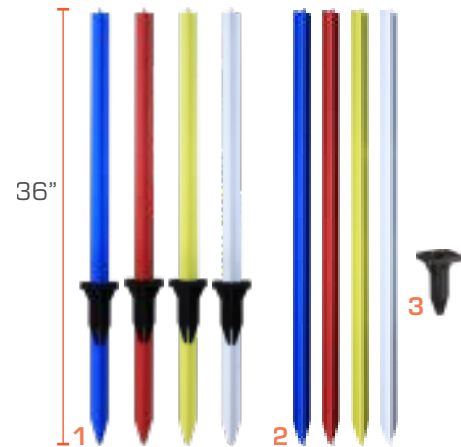

SMP Fairway Distance Markers

1. Complete Unit [No. 293]
2. Replacement Stake [No. 293-01]
3. Replacement Base [No. 293-02]

Made with 3/8" thick fiberglass rod and red powder coated aluminum round head. Available with white or yellow rod.



Red Head Practice Green Markers

Decal:	Part Number:
Blank	274/BLANK/R
Set of 1-9	274/1-9R
Set of 10-18	274/10-18R

Made of strong plastic, this placement marker slides onto the flag poles. It is equipped with a rubber ring which holds the ball in place.

- Yellow ● Red
- Blue White



Plastic Placement Markers [No. 324]

Made of durable recycled plastic, this solid cube marker measures 4"x4"x4" (LxWxH) and comes complete with a galvanized steel spike.

- White Black ● Red
- Yellow ● Blue



Recycled Plastic Cube Tee Markers [No. E800]

Made of durable, color saturated plastic and comes complete with a galvanized steel spike. Custom decals available, sold separately.

- Red ● Blue Black
- White ● Yellow



Customizable Solid Tee Marker [No. 813]

Please contact us for the most up to date availability of clearance items.

Pro Hole Cups are designed and finished to precise standards, resulting in a world class greens cup. Completed with locking ferrule system that ensures unnecessary premature wear of the flag pole ferrule.



Pro Hole Cup [No. 253PL]

This cup is made of hard plastic material.

Flagpoles

Regulation Poles (1/2")

- White Pole with 2 Black Stripes
- Yellow Pole with 2 Black Stripes
- White Pole with 2 Green Stripes
- White Pole with 3 Black Stripes
- Yellow Pole with 3 Black Stripes
- White Pole with 3 Red Stripes
- Woodgrain Pole



	7'	7.5'	8'
White Pole with 2 Black Stripes	300BW-72A	-	-
Yellow Pole with 2 Black Stripes	300BW-72	-	300BW-82
White Pole with 2 Green Stripes	300YB-72	-	-
White Pole with 3 Black Stripes	300GW-72	-	-
Yellow Pole with 3 Black Stripes	300BW-73	-	300BW-83
White Pole with 3 Red Stripes	300YB-73	300YB-753	300YB-83
Woodgrain Pole	300RW-73	-	-

Available while quantities last. Please give us a call for the most up to date stock availability.

Bayco Golf fiberglass poles are manufactured to the highest quality and appearance for excellent corrosion and weather ability. The regulation poles are 1/2" thick and the tournament poles are tapered, reaching 3/4" in the middle. They come in variety of sizes and colors/stripes. The poles are veil wrapped to increase lifespan and reduce fiberglass splinters.

Every flag pole is top threaded and color impregnated throughout which means that the color will not peel off or fade with time.

The flag poles are completed with a smooth ferrule and with a top acorn nut that will suit the swivel for grommet style flags or tube style flags.

When shipped, we add a sleeve on bushing and ferrule for additional protection.

Tournament Poles (3/4")

- White Pole
- White Pole with 1 Black Stripe
- Yellow Pole with 1 Black Stripe
- White Pole with 2 Black Stripes
- Yellow Pole with 2 Black Stripes
- White Pole with 3 Black Stripes
- White Pole with 3 Black Stripes
- White Pole with 1 Red Stripe
- White Pole with 2 Red Stripes
- Yellow Pole with 2 Green Stripes

	7'	8'	10'	12'
White Pole	-	-	-	300TW-12
White Pole with 1 Black Stripe	-	-	-	300TBW-121
Yellow Pole with 1 Black Stripe	-	-	300TBY-101	300TBY-121
White Pole with 2 Black Stripes	300TBW-72	300TBW-82	-	-
Yellow Pole with 2 Black Stripes	300TBY-72	300TBY-82	300TBW-102	-
White Pole with 3 Black Stripes	-	300TBW-83	-	-
White Pole with 3 Black Stripes	-	300TBY-83	-	-
White Pole with 1 Red Stripe	300TRW-71	-	-	-
White Pole with 2 Red Stripes	-	-	-	-
Yellow Pole with 2 Green Stripes	300TGY-72	-	-	-

ABOUT BAYCO

Our Name Stands for *Quality*

Bayco Golf started out unlike the typical business. The founder, Alex Colonelo, came from a mechanical toolmaker background. He started working at a company called Bay Bronze Industries which manufactured fuel fittings and plumbing parts as well as bronze signs and plaques. His passion for golf and his experience in manufacturing inspired him to start a golf course accessories division within Bay Bronze in 1986 (renamed to Colon Industries at this time). In 1998, he bought off the golf division and named the company Bayco Golf Inc where he became a president. He retired in 2006 when OSC Seeds purchased Bayco Golf and a new general manager, Cal Surgenor, was appointed.



Bayco Golf has always strived to bring the best quality of products to the golf course accessory market. With our knowledgeable team and many years of experience, you can remove all uncertainty with anything related to your course. We build meaningful relationships with clients that last a lifetime. We pride ourselves that almost all our products are manufactured locally in North America. We are a forward thinking, market improving company that has set the bar for numerous products, including but not limited to, Dye Sublimated Custom Flags, Pro Hole Cups with Liner and Locking Ferrule, ColorFlex Distance Markers, and our newest addition – The Mully Cup Lifter.

The little train that could – did. We are one of the top manufacturers/suppliers in the world. We ship internationally in over 50 countries and our products are found on the most prestigious golf courses in the world. We design custom flags, markers, cup liners, plaques, signs and more! Our customers vary from a private individual who wants to build a small putting green in their back yard, to 36-hole resort golf courses around the world.

If you are looking for a reliable and knowledgeable staff to help you with your golf course accessory needs, look no further! Call us today and we would be happy to help you!

Get on course with **BAYCO!**

Meet the Managers!



Cal Surgenor (Left), Shelley Drul (Middle), and Andrew Hunt (Right)

Cal Surgenor is the General Manager at Bayco Golf. He took over in 2006 after OSC Seeds purchased the company from Alex Colonelo. He has a background in sales and is passionate about golf which made him the perfect candidate. Cal is very personable and loves to help out fellow golfers with anything golf related.

Shelley Drul is the Customer Service Manager at Bayco Golf. She deals with most customer affairs and specializes in the customizable products, like flags, signs, decals, and more. She has been with the company since 2004 and has made deep connections with all of our customers and distributors. She is friendly, easy going, and resourceful, ready to help with any purchase or inquiry.

Andrew Hunt is the Operations Manager at Bayco Golf. He manages overall operations and is responsible for the effective and successful management of labor and productivity. He is a golfer himself and has experience both as a golf player and an employee at a golf course. He knows the ins and outs of the golf business and products and has Golf Pro experience. In short, he lives and breathes golf.

Items in Alphabetical Order

B

Ball Washers

Ball Washer Ensembles	2
Crank Style Ball Washer Parts	6
Crank Style Ball Washers	6
Custom Plunger Style Ball Washers	5
Detergents	7
Ensemble Accessories and Parts	5
Plunger Style Ball Washer Parts	4
Plunger Style Ball Washers	4

Broken Tee Caddies

Aluminum Broken Tee Caddies	13
Plastic Broken Tee Caddies	13
Recycled Plastic Broken Tee Caddies	13

C

Clearance

Customizable Solid Tee Markers	56
Flagpoles	57
Greens Flags	55
Plastic Placement Markers	56
Plastic Pro Hole Cups	56
Practice Flags	54
Recycled Plastic Cube Tee Markers	56
Red Head Practice Green Markers	56
SMP Fairway Distance Markers	56

Club Washers

Aluminum Club Washer Parts	6
Aluminum Club Washers	6
Detergents	7

Course Tools

36" Plug Pushers	41
Aerifiers	40
Aluminum Landscaper Rakes	41
Back Pack Sprayers	41
E-Z Reachers	41
Roller Squeegee	41
Soil Samplers	40
Sprinkler Head Trimmers	41

Cup Installation and Maintenance

Aluminum Cup Setters	25
Cup Pullers	23
Curved Trimming Scissors	23

Hole Cutter Blade Replacements	22
Hole Cutter Flanged Stop	22
Hole Cutter Guide	22
Hole Cutters	22
Hole-In Paint	23
Hole-In Paint Tools	23
Plastic Cup Covers	25

Custom Signs

Aluminum Directional Signs	37
Bronze and Aluminum Fairway and Distance Markers	36
Bronze and Aluminum Tee Signs	37
Customizable Aluminum Signs	37
Customizable Heavy Duty Steel Signs	36
Recycled Plastic Custom Easels	36
Recycled Plastic Tee Signs	37

D

Divot Mix, Sand & Seed

Divot Mix Containers	11
Divot Mix Plastic Scoops	11
Personal Sand and Seed Bottles	10
Sand & Seed Bottle Holders	10
Sand & Seed Bottle Racks	11
Sand & Seed Bottles	10

Driving Range

Range Banners	47
Range Club Washers	46
Range Tube Flags	46

E

Eco-Blast Air Horns	51
E-Z Litter Sticks	51

F

Fairway Distance Markers

ColorFlex Distance Markers	17
Color Flex Installation Kit	17
Domed Aluminum Distance Markers	18
Domed Polymer Distance Markers	18
Recycled Plastic Hazard Markers	17
SMP Fairway Markers	18

Flag Poles

Bayco Guard for Flag Poles	28
Bayco Laser Reflectors	28

DIY Laser Reflectors	28
Elite Laser Reflectors	28
Ferrules	26
Flag Pole Holders	26
Regulation Poles	26
Smart Stick Poles	28
Smarty Reflectors	28
Tournament Poles	27

Furniture

Benches	12
Cup Dispensers	12
Golf Bag Racks	51
Portable Outdoor Ashtray	51
Solo Cups	12
Spike Cleaner Brushes and Replacement Parts	50
Spike Cleaner Stands	50
Water Cooler	12

G

Greens Cups

Aluminum Pro Hole Cups	24
Mully Cup Lifters	25
PGA Greens Cups	24
Plastic Cups with Bronze Insert	24
Plastic Greens Cups	24
Plastic Pro Hole Cups	24
SpeedWrap Liners	25
Temporary Aluminum Greens Cups	24

Greens Flags

Custom Flags	30
Golf Ball Tender	25
Greens Flags	29
Quick Click Top Attachments	29
Top Acorn Nuts	29
Top Security Nuts	29

Greens Maintenance

Bayco Golf Coco Drag Mats	33
Bayco Guard for Rake Handles	32
Dew Whipping Poles	33
Greens Speedmeters	33
InstaFix Ball Mark Repair Tools	33
Sand Trap Rake Handles	32
Sand Trap Rake Heads	32
Sand Trap Rakes	32

P

Paint

Marking Pistol	19
Marking Wands	19
Rust-Oleum Precision Line Marking Paint	19

Practice Area

Chipping Greens Ball Pushers	45
Gimme Practice Greens Markers	44
Practice Greens Poles	44
Practice Greens Tube Flags	45
Red Head Practice Greens Markers	44

Proximity Markers

51

R

Rope

Bungee Rope	18
Rope Stakes	17
Three Strand Braided Rope	18

T

Tee Markers

Round Plastic Tee Markers	13
Solid Aluminum Tee Markers	13
Tear Drop Tee Marker	13

Tee Towels

7

Trash Receptors

Designer Series Litter Bins	9
Litter Basket Parts and Attachments	8
Litter Baskets	8
Litter Bin Lids, Parts, and Stands	9

Toll Free Phone Number:
1 (877) 668-4653

www.BAYCOGOLF.com

BAYCO GOLF
206 Saulteaux Cres
Winnipeg, MB R3J 3W3
Ph: (204) 633-8881
Fax: (204) 633-6226
E-Mail: contact@baycogolf.com

DISTRIBUTED BY:



RETURN POLICY

Bayco Golf strives for complete customer satisfaction at all times, however, in the unlikely event you are not completely happy with your purchase you may request a refund. All refund requests must be made within 7 days of delivery date. Please include your invoice number and name when contacting us. All items must be in a new/unused condition, in original packaging, and with all paperwork, parts, and accessories. Once the merchandise has been received and passed a satisfactory inspection, a refund will be issued onto the original method of payment and in the original currency (less the outbound and inbound shipping fees, where applicable). All returned items are subject to a \$10 restocking fee.

Exchange of items is only accepted if the item is damaged or has manufacturer's defects (proof upon request is needed). In this case, Bayco Golf will cover the shipping costs. If the item cannot be repaired, we will replace the item and send it back to the Customer at our own expense.

Exception to items include:

- Clearance Items – these are discontinued items that we wish to sell out of. We regret to say that items purchased as "Clearance" are not eligible for returns or exchanges.
- Custom Items – Custom items cannot be resold and therefore we cannot accept returns on them. Please note that it is the **Customer's responsibility** to ensure clarity in communication and to approve provided proofs for custom work. However, if a mistake is made on our end, Bayco Golf will re-do and replace the merchandise at no expense to the customer.
- Any other item that cannot be re-sold, that includes but is

not limited to items in used condition that do not qualify for our warranty or items reduced due to damage or defect and marked as final sale.

We reserve the right to warn, limit or decline returns or exchanges regardless if the item answers to all the conditions mentioned above. Notwithstanding, we may change or modify the agreement in part or completely without notice and we will not be held responsible for any loss or damage suffered as a result of such changes.

WARRANTY

Bayco Golf warrants products to be free from defects in materials and workmanship under correct use and proper applications for a period of six (6) months or one golf season from the original date of purchase. Warranty requests must be made immediately upon finding a defect and proof must be provided. The suitability of whether the merchandise satisfies the conditions of the warranty are determined solely by Bayco Golf. After passing a satisfactory inspection and concluding that the damage falls under the warranty, Bayco Golf's obligations are limited to the repair or exchange of the item at no cost to the client. Should the merchandise not satisfy the conditions of the warranty, Bayco Golf reserves the right to refuse or otherwise limit the return/repair/exchange of the item. **The warranty does not cover damages due to negligence, improper use or maintenance, weather conditions, theft, or natural disasters.**

CATALOG 2021