



BAYCO

Golf

GOLF COURSE ACCESSORIES

2025

Get on course with **BAYCO!**

Our Name Stands for *Quality*

Bayco Golf has been an industry leader in golf course accessories since 1986. Our products are found on the most prestigious golf courses all around the world! With almost 40 years of experience and our diverse line of products, we can meet the needs and outfit any type or size of golf course. No job is too big or small – whether you are constructing a 36-hole resort course or a small putting green in your back yard, we have what you are looking for!

Get on course with **BAYCO!**

Call us today to place your order 1 (877) 668-4653



Featured Products



**ARMOURED
GRIP HANDLES**
BETTER GRIP &
PREVENTS SPLINTERING

Armoured Rake Handle
p. 45



Reflective Flag
p. 4



Bucket of Stakes
p. 27



Bayco Golf proudly sources more than 95% of its products from North American manufacturers and suppliers.

Featured Products



Model 700 Ball Washer
p. 10



Personal Sand & Seed Bottle
p. 13



Litter Basket
p. 15



Model 699 Ball Washer
p. 10



White Plastic Cup Collar
p. 36



Fiberglass Woodgrain Pole
p. 39



Bayco Golf proudly sources more than 95% of its products from North American manufacturers and suppliers.

TABLE OF CONTENTS



PRACTICE AREA
P. 63-70



CUSTOM FLAGS
P. 1 - 4



DOWN THE FAIRWAY
P. 23-28

PRO SHOP

CLUB HOUSE

DRIVING RANGE

100

150

200

250

300



COURSE SIGNAGE
P. 47-56

PRO SHOP & CLUB HOUSE
P. 71-75



AROUND THE GREEN
P. 29-46



TEE BOX AREA
P. 5-55

MAINTENANCE



GOLF COURSE TOOLS
P. 57-62



CLEARANCE
P. 76

Detailed Table of Contents on the Next Page

ASK US ABOUT...



Custom Flags

Our custom flags will not disappoint! We have several fabric and sizes to choose from. More information on p. 1 - 4 .

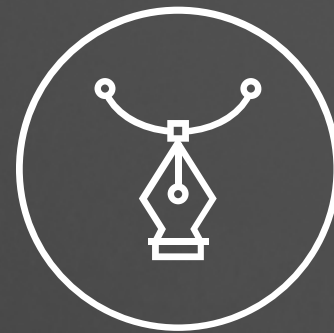

Illustration Services

If your logo is outdated or you don't have the proper files - we've got you covered! We offer drawing and re-tracing services. Please contact us for more information.



Golf Tournament Accessories

Bayco Golf loves tournaments! Let us help you with the custom designs of your golf course accessories.



Design Inspiration

Bayco Golf can help you with the design ideas for your custom items.



Customized Ball Washers

Our Model 700/770 plunger style ball washer has the added ability to include a custom decal.



Custom Signage

We offer several different signage styles and materials. For more information, please go to p. 48.

Table of Contents

| | | |
|-----------------------------------|-------------------------|---------------------------------|
| CUSTOM FLAGS | 1 COURSE SIGNAGE | 47 |
| CUSTOM FLAG FAQ'S | 2 | CAST IN MOLD CUSTOM SIGNAGE |
| REFLECTIVE FLAG | 4 | RECYCLED PLASTIC CUSTOM SIGNAGE |
| TEE BOX AREA | 5 | CAST IN MOLD GROUND TEE MARKERS |
| BALL WASHER ENSEMBLES | 7 | RECYCLED PLASTIC EASELS |
| PLUNGER STYLE BALL WASHERS | 10 | SPONSOR SIGNAGE |
| DETERGENT | 11 | ACP CUSTOM SIGNAGE |
| ENSEMBLE ACCESSORIES | 11 | HEAVY DUTY SIGNAGE |
| DIVOT MIX CONTAINERS | 13 | ALUMINUM & DIRECTIONAL SIGNAGE |
| SAND AND SEED BOTTLE RACK | 13 | COURSE TOOLS |
| SAND AND SEED BOTTLES | 14 | SOIL SAMPLERS |
| LITTER BASKETS | 15 | AERATORS |
| DESIGNER SERIES LITTER BINS | 16 | SPRINKLER HEAD TRIMMERS |
| TEE TOWELS | 17 | LANDSCAPERS AND SQUEEGEES |
| WATER COOLERS | 17 | OTHER MAINTENANCE TOOLS |
| BENCHES | 18 | PRACTICE AREA |
| BROKEN TEE CADDIES | 19 | PRACTICE GREENS MARKERS |
| ALUMINUM TEE MARKERS | 20 | PRACTICE GREENS POLES & BASES |
| PLASTIC TEE MARKERS | 21 | PRACTICE GREENS FLAGS |
| DOWN THE FAIRWAY | 23 | RANGE FLAGS |
| COLOR FLEX MARKERS | 26 | CHIPPING GREENS BALL PUSHER |
| FAIRWAY DISTANCE & HAZARD MARKERS | 26 | RANGE CLUB WASHERS |
| ROPE STAKES | 27 | CUSTOM RANGE DIVIDERS |
| BRAIDED & BUNGEE ROPE | 27 | RANGE BANNERS |
| PAINT AND MARKING TOOLS | 28 | PRO SHOP & CLUBHOUSE |
| AROUND THE GREEN | 29 | SPIKE CLEANER STANDS & MOUNTS |
| HOLE CUTTERS | 31 | BRUSH ASSEMBLIES |
| CUP PULLERS | 32 | REPLACEMENT BRUSHES & ASSEMBLES |
| TRIMMERS | 32 | OTHER FURNITURE |
| ALUMINUM & PLASTIC CUPS | 33 | ECO BLAST AIR HORNS |
| CUP LINERS | 34 | PROXIMITY MARKERS |
| ALUMINUM PRO-HOLE CUPS | 34 | UNIVERSAL FLAG HOLDER |
| CUP ACCESSORIES | 35 | |
| WHITE PLASTIC CUP COLLAR | 36 | CLEARANCE |
| CUP SLEEVES | 36 | |
| REGULATION 1/2" POLES | 37 | ABOUT BAYCO |
| TAPERED TOURNAMENT 3/4" POLES | 38 | |
| REGULATION SMARTY STICKS | 39 | INDEX |
| WOODGRAIN REGULATION FLAG POLE | 39 | |
| TOURNAMENT SMARTY STICKS | 40 | |
| HARDWOOD TOURNAMENT POLES | 40 | |
| REFLECTORS | 41 | |
| FLAGPOLE RESTORATION | 41 | |
| COURSE & SPECIALITY FLAGS | 43 | |
| FLAG ACCESSORIES | 43 | |
| RAKE HEADS | 45 | |
| RAKE HANDLES | 45 | |
| COMPLETE RAKES | 45 | |
| COCO DRAG MAT | 46 | |
| GREENS TOOLS | 46 | |
| BALL MARK REPAIR TOOL | 46 | |

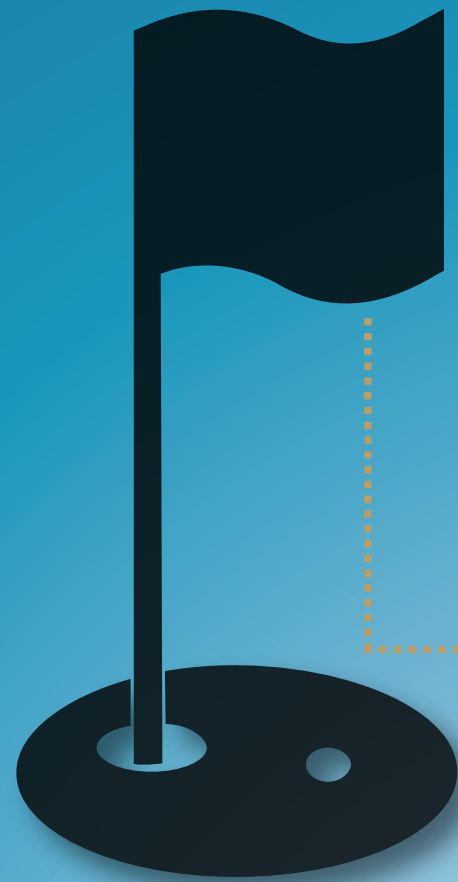

ANY COLOR COMBINATION



If you can imagine it, we can print it! Whether you need assistance selecting the perfect colors to complement your logo, or you already have a specific color in mind (HEX, RGB, CMYK), we can match it precisely. We can even adjust your logo's colors to suit your needs!*

ANY LAYOUT

Whether you want a border, numbers, text, or just your logo** on the flags, we can make it happen! If you have a custom graphic you'd like to feature, or you'd like to showcase your sponsors, we've got you covered. Need to promote a new feature or honor someone special? With Bayco Custom Golf Flags, the possibilities are endless!

UNLIMITED CHOICE - ONE PRICE

We offer a variety of custom golf flag sizes, with the 14"x20" and 6"x8" being the most popular. Choose from three shapes—rectangle, burgee, or pennant—and select either single-sided (SS) or double-sided (DS) printing. Our prices remain consistent across all flag types and sizes, regardless of colors or design layout. There are no setup fees for proofs, and you can request changes until you're completely satisfied! Get creative—the only limit is your imagination!

*Logos must be high resolution and be either a PDF or a vector file (.ai or .eps)

** Any graphics or logos must be obtained legally and have all the required permissions to be used in your custom flag design. Bayco Golf is not responsible for any lawsuit related to the distribution of illegally obtained content.

CALL 1 (877) 668-4653 OR YOUR NEAREST BAYCO DISTRIBUTOR TO ORDER YOURS TODAY.

Possibilities are endless!

SIMPLY - THE FINEST QUALITY CUSTOM GOLF COURSE FLAGS

Frequently Asked Questions:

WHAT IS DYE SUBLIMATION PRINTING?

Dye Sublimation is a printing process which reproduces graphics and images into various flexible and rigid substrates – in our case, fabric. Using a combination of high heat and pressure, solid dyes are absorbed directly into the fabric, creating many advantages over traditional screen-printed graphics.

HOW ARE OUR FLAGS MADE?

Once a design is approved, the graphic files are fitted onto a template using Illustrator. Those files are printed and then sublimated into the fabric. The fabric portion with dye is cut out and passed on to our sewing and finishing department. After finishing, the products are cleaned, checked and are packaged for shipping.

WHAT FORMAT SHOULD YOUR ARTWORK BE IN?

Please ensure that your artwork files are of good quality, preferably vector (.ai or .eps). Raster images, such as JPEG and PNG can be submitted but extra charges may apply should we need to re-draw them in a vector format. If you are unsure of what files you currently have, please contact us and we can assess them for you.

HOW LONG TO COMPLETE FLAGS?

Once we send you the proofs and they are approved by you, it typically takes 2-4 weeks for them to be printed (on a first come, first serve basis). Shipping (depending on location) can take additional 3-7 business days in North America. Please contact us for a more accurate timeline for your specific project.

WHAT FABRIC CHOICES DO YOU OFFER?

- **Poplin Flags** - Our poplin flags are great for heavy graphics and double sided flags because it uses an optional blocker to prevent see-through from front to back. **Note:** It is the heaviest option especially if the blocker is added. This fabric needs wind to move.
- **Dura Flags** - Very stable fabric that is porous and allows wind to move through it. It has 95% transparency which makes it perfect for single sided flags.
- **Poly Silk Flutter** - This fabric is recommended for events as it flutters even in low breeze settings. It has 98% transparency and is very lightweight, perfect for single sided flags.

HOW IS VECTOR DIFFERENT THAN RASTER?

Simply put, raster images are created by pixels and their quality depends on the DPI (dots per inch) or PPI (pixels per inch). The lower the DPI, the more "pixelated" it looks. Raster image files include .jpeg, .png, and .tiff formats.

Vector images are made up of paths with mathematical formulas telling the path what color or shape it needs to be. Thus, vector images retain their appearance regardless of size and can be scaled infinitely. Although vector files are rarely used for photographs or paintings, they are perfect for designs such as logos and illustrations. Vector files include .ai, .eps, and .dmg formats.



WHAT CAN WE PRINT WITH DYE SUBLIMATION?

Bayco Golf has worked on a variety of custom projects for different events and purposes, ranging from tournament flags to memorials and anniversaries. We handle it all! Some of the services we offer include solid-colored flags, numbered flags, and argyle designs in any color. We can create flags in different shapes and sizes, including custom options, as well as tournament flags featuring special graphics. Additionally, we provide flags for sponsors and advertisements, memorial tournaments, and printed pictures or enlargements. We also offer Hole-In-One flags for framing and giveaways, banners, oversized flags, custom-sized country flags, and any combination of design and layout you require.

FLAG SIZES



1. Range Flags - 18" x 26"
2. Regulation Flags - 14" x 20"
3. Practice Greens Flags - 6" x 8"

FLAG ATTACHMENTS



FLAG SHAPES



Rectangle
All Sizes



Burgee
14" x 20" only



Pennant
14" x 20" only

BAYCO GOLF REFLECTIVE FLAGS

Features:

- A cost-effective alternative to conventional reflectors, offering a larger reflective surface area without the need for purchase additional lasers.
- Each Bayco Reflective Flag includes 14 inches of reflective material along the entire side of the flag, ensuring maximum visibility from any angle and making it easier for golfers to spot the flag.
- Durable and weather-resistant, these flags are designed to withstand the demands of the golf course, ensuring long-lasting performance and reliability.



EXAMPLES OF LAYOUT IDEAS

Below are some examples of layout ideas to spark some inspiration. However, don't limit yourself - with dye sublimation the only limit is your imagination!



TEE BOX AREA



Tear Drop Marker
Part No. 816BL
Page 20

TEE BOX AREA



Model #700 Ball Washer
Part No. 700GR
Page 10

Designer Series Litter Bin
Part No. 765GR
Page 16

Recycled Plastic Bench
Part No. EE1214
Page 18

| | |
|-----------------------------|----|
| BALL WASHER ENSEMBLES | 7 |
| PLUNGER STYLE BALL WASHERS | 10 |
| DETERGENT | 11 |
| ENSEMBLE ACCESSORIES | 11 |
| DIVOT MIX CONTAINERS | 13 |
| SAND AND SEED BOTTLE RACK | 13 |
| SAND AND SEED BOTTLES | 14 |
| LITTER BASKETS | 15 |
| DESIGNER SERIES LITTER BINS | 16 |
| TEE TOWELS | 17 |
| WATER COOLERS | 17 |
| BENCHES | 18 |
| BROKEN TEE CADDIES | 19 |
| ALUMINUM TEE MARKERS | 20 |
| PLASTIC TEE MARKERS | 21 |

TEE BOX AREA

ENSEMBLES



Completely customizable with any of our interchangeable ensemble components. Mix and match colors, towels, can lids, ball washers and more!

TEE BOX AREA

ENSEMBLES



Don't forget to ask us about customizing your ensemble with your course logo. The combinations and possibilities are endless!

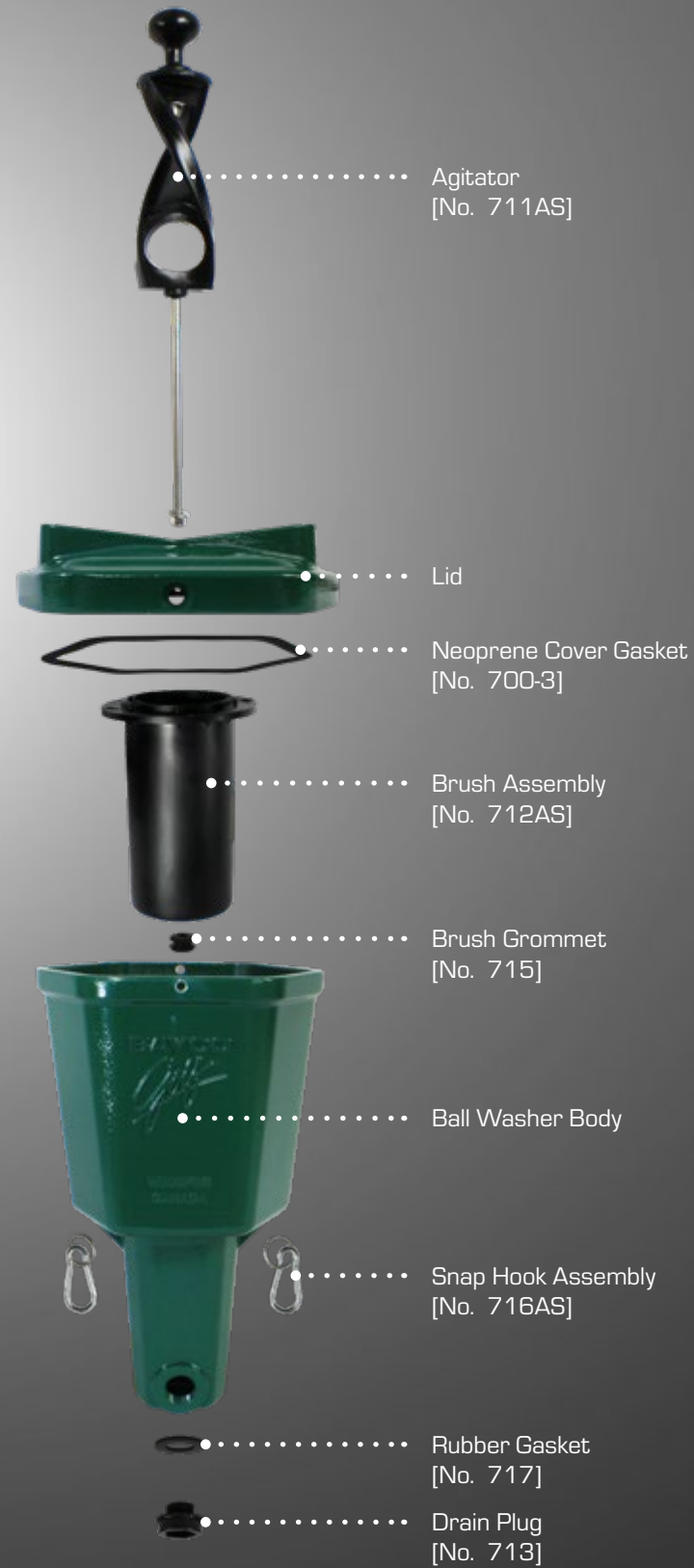

PLUNGER STYLE BALL WASHERS INCLUDED:

All of our plunger style ball washers are made of cast-in-mold aluminum alloy and feature durable polymer and stainless steel internal components, providing years of trouble free service.

- Green ● Red ● Black ● Copper Vein

* Custom colors are available.
* Minimum Order of 20 for Copper Vein



Plunger Style Ball Washer [No. 700]

Our signature ball washer.
Capacity: 7.2 US Pints/3.4L
Cleans 1 ball at a time.

INCLUDED:

- Easy grip replaceable agitator knob
- Flanged cover does not seize and is easy to remove
- Brush assembly firmly fastened underneath cover with stainless steel cap screws
- Powder coated color finish ensures durable and beautiful color for years



Plunger Style Ball Washer [No. 699]

Our smaller model is manufactured to the same quality as the 700 ball washer.
Capacity: 5 US Pints/2.37L
Cleans 1 ball at a time.

* Minimum Order of 20 for Copper Vein



Customizable Ball Washer [No. 770]

Our Model 700 ball washer with added ability for custom logo*
Capacity: 7.2 US Pints/3.4L
Cleans 1 ball at a time.

** Minimum order: 9 for red, green and black; 18 for copper vein



TEE BOX AREA

DETERGENT

Our liquid and tablet detergents leave the balls, ball washers and club washers sparkling clean and debris free.



Detergent Soap Tablets [No. 718T]
500g/container. One tablet per ball washer fill. Convenient and portable.



Heavy Duty Detergent [No. 718]
4L container. Mix 1 part concentrate to 4 parts water

REPLACEMENT BRUSH

For 690 Club Washer
Two brushes per Club Washer.
Sold individually.



Replacement Brush [No. 690-3]

ENSEMBLE ACCESSORIES

Stand Pipes are made of aluminum and powder coated black.
ID 2 1/8"; OD 2 3/8".

*Pipes sold separately in black only.



1. 34" Stand Pipe [No 702BK-34]
The 34" pipe is for the 701 base.
2. 46" Stand Pipe [No. 702BK-46]
The 46" pipe is for direct burial.

The stand base made of cast aluminum and has powder coated finish.
**Spikes sold separately.

● Green ● Red ● Black ● Copper Vein

* Custom colors are available.
* Minimum Order of 20 for Copper Vein



Ball Washer Stand Base [No. 701]
The Stand Base acts as a universal base unit for all of our ball washer Ensembles.

BALL WASHER REPAIR KITS

Everything you need to bring your ball washer back to life! The repair kit fits all quality brand plunger style units. Includes all parts listed below; they are also sold separately.



Plunger Style Repair Kit [No. 721KIT]

- 1. Snap Hook Assembly [No. 716AS]**
Complete with stainless steel key rings which hook onto the ball washer. They allow you to add a tee towel to your ensemble.
- 2. Rubber Drain Plug Gasket [No. 717]**
- 3. Drain Plug Wrench [No. 714]**
Used to tighten and remove the drain plug.
- 4. Drain Plug [No. 713]**
- 5. Allen Keys [No. 714-1 (5/32" cal.)] [No. 714-2 (3/16" cal.)]**
- 6. Brush Assembly [No. 712AS]**
- 7. Agitator Assembly [No. 711AS]**

Secures the base to the ground.
Sold in sets of three.
Size: 5/16 - 18NC, 4" long, 3/8"
For 701 base



4" SS Spikes [No. 801-3]

Attaches to the 701 base. Sold individually.
Measures 5.25"x5.75"



Foot Brush w/ Screws [No. 610]

Allows the ball washers to be attached to any wall. Works with the aluminum club washers, as well. Hardware not included due to wide variety of wall materials.
Sold in black only.

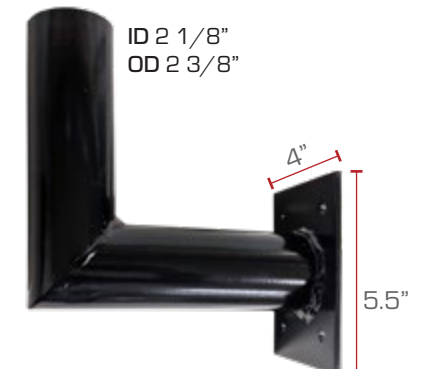

Ball Washer Wall Mount [No. 692BK]

TEE BOX AREA

DIVOT MIX CONTAINERS

These maintenance free polyethylene containers are ideal for your tee or range areas. The lid is engineered to keep your mix dry and provide easy access.

● Brown ● Green ● Black

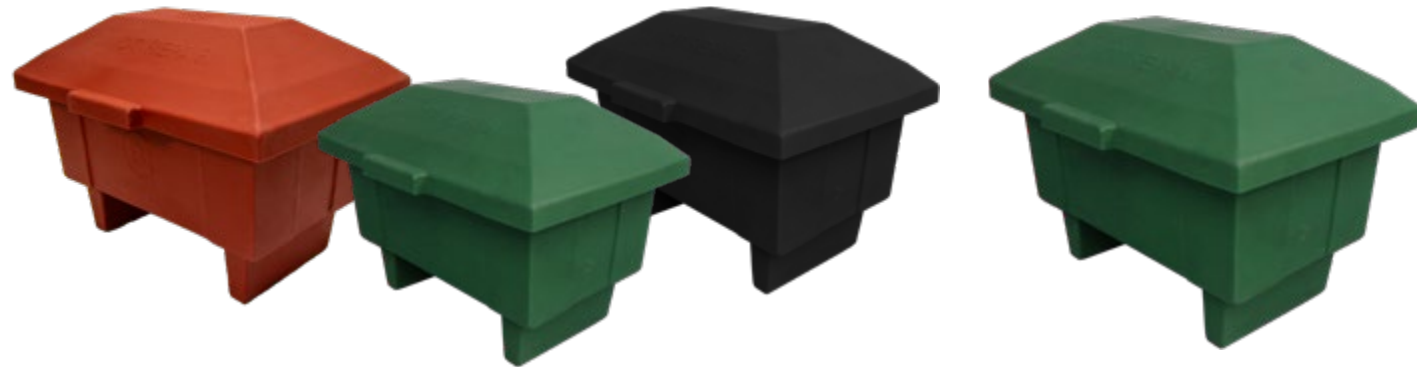

Divot Mix Container (M) [No. 696]
16.8L Capacity; 12 oz plastic scoop included with every container.
Approx. Size (LxWxH): 19.5"x14"x16"

Divot Mix Container (L) [No. 697]
42.4L Capacity; 12 oz plastic scoop included with every container.
Approx. Size (LxWxH): 23.5"x16"x18"



12 oz Plastic Scoop [No. 233BK]

A 12 oz scoop is included in every Divot Mix Container. Simple, ergonomic, polyethylene plastic scoop for your divot mix container

SAND AND SEED BOTTLE RACK

Rear handle for easy push or pull of the rack.

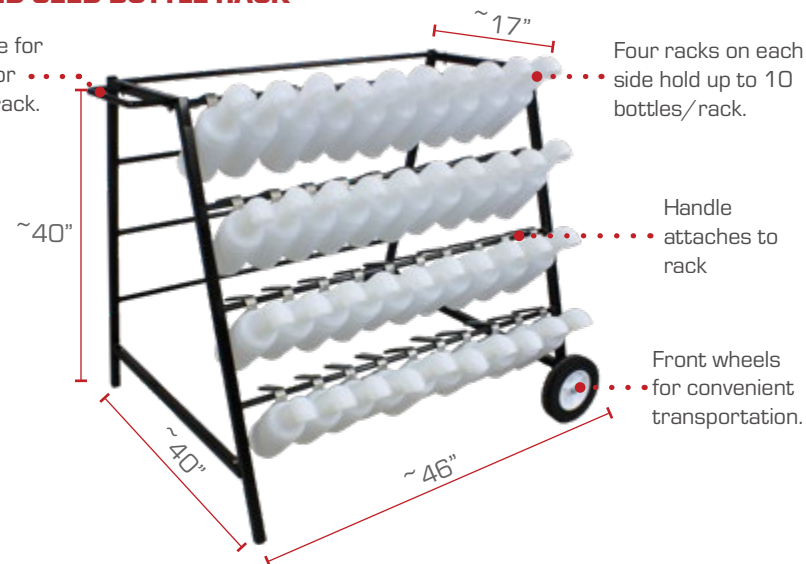

Four racks on each side hold up to 10 bottles/rack.

Handle attaches to rack

Front wheels for convenient transportation.

Sand and Seed Bottle Rack [No. 243]

Convenient mobile rack, holds up to 80 bottles.* Ships flat for economy, assembles easily.
*Bottles sold separately.

1. Personal Sand and Seed Bottle [No. 234P]

0.5L Capacity

2. Replacement Parts for 234P [No. 234P-KIT]

Replacement bottom cap, top lid, and clip.



A slimmer solution with an air tight lid that pops on and off for easier refill and a clip which allows it to snap onto any golf bag.

SAND AND SEED BOTTLES

Our sand and seed bottles have a screw on/off bottom lid with wide opening for easy filling. Made of heavy duty plastic. Ergonomically designed for easy transportation and with narrower base, these bottles fit in any bottle holder.

Made to the same quality as all of our sand and seed bottles, this bottle is complete with a molded in handle.



Sand and Seed Bottle [No. 234]
1L Capacity



Rattle Proof Sand and Seed Bottle [No. 234R]
1.3L Capacity
Fits universal rattle proof holder (No. 245)



Sand and Seed Bottle with a Metal Handle [No. 234H]
1L Capacity; attaches to the bottle rack. Uses 234 bottle Replacement Bottle Handle Assembly [No. 234AS]



Rattle Proof Sand and Seed Bottle with Molded In Handle [No. 234RH]
1.3L Capacity; Built-in handle

SAND AND SEED BOTTLE ACCESSORIES

Our screw-on caps fit all of our Sand and Seed Bottles.

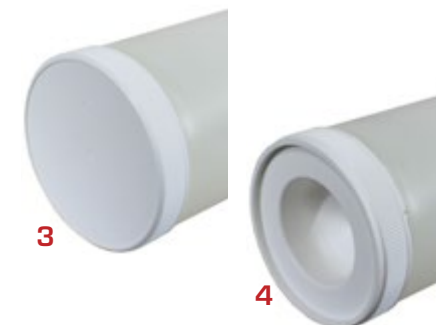

3. Replacement Screw-On Cap with Flat Bottom [No. 234H-3]
Fits the 245 bottle holder only.

4. Replacement Screw-On Rattle Proof Cap [No. 234R-1]
Fits all bottles and bottle holders.

Attach the Sand & Seed bottles to virtually any cart. Please contact us for a quote.



Rattle Proof Design



Sand and Seed Bottle Holder [No. 245]
Bottle holder for rattle proof Sand & Seed bottles[234R]. Includes hardware.



Rattle Proof Sand and Seed Bottle with Holder [No. 234R-KIT]
Includes: 234R & 245 with hardware.

LITTER BASKETS

The litter baskets are available in 9 gal size and in three different colors*. Made with 20 gauge steel and with powder coated finish. Available in three different bases to fit your application requirements.

● Green ● Red ● Black ● Blue



* Custom colors are available upon request. Minimum order applies, please contact us.

Litter Basket with Spike Base [No. 750]

Perfect for installing into a soft surface, such as grass.

Litter Basket with Flat Base [No. 754]

Sturdy base for any application.

Litter Basket with Cone Base [No. 755]

Sturdy base for any application.

Bases available only in black

LITTER BASKET BASES



- 1. Steel Spike Base [No. 750-5]
- 2. Flat Base [No. 759]
- 3. Cone Base [No. 760]

LITTER BASKET ENSEMBLE ATTACHMENTS



- Stand Base Mount [No. 745]
Attaches to the 701 base stand in the same fashion as the 610 foot brush.

DESIGNER SERIES LITTER BINS

Made of strong polyethylene plastic, these litter bins and lids are ergonomically designed to add elegance to both the ball washer ensemble and on their own. Lids sold separately.



- 1. Trash Lid Opening [No. 766T]
 - 2. Solid Lid (No Opening) [No. 766S]
 - 3. Can Lid Opening [No. 766C]
- Sold in black only.



Designer Series Litter Bin [No. 765]

All stands are made of aluminum and powder coated black.

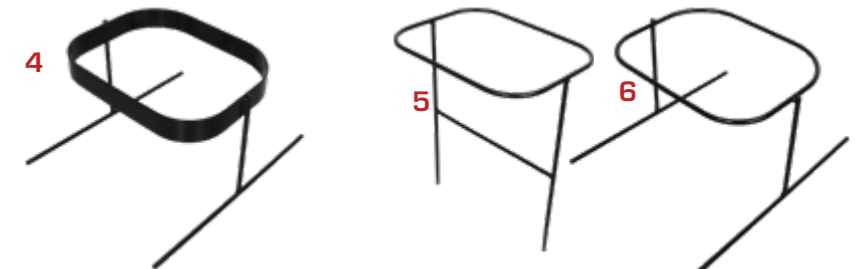

- Heavy Duty Litter Bin Stands
- 4. Above Ground Stand [No. 748C]
- *WQL*

- Slim Litter Bin Stands
- 5. In-ground Stand [No. 748B]
- 6. Above Ground Stand [748D]

LITTER BIN ENSEMBLE MOUNTING BRACKETS

Mounts are made of aluminum and powder coated black. They wrap around a 2" Ensemble Pipe and can support one or two Litter bins. All necessary hardware included.



Double Mounting Bracket [No. 747BK]

Single Mounting Bracket [No. 746BK]

TEE BOX AREA

TEE TOWELS

100% cotton with smooth cotton threads producing a very soft feel. Sold in black & green. 12 towels/pkg. Towel Full Length: 24.5 inches. *Embroidery available, please contact us.



Elite Cotton Center Grommet Towel
Black Towel [No. 730BK]
Green Towel [No. 730GR]

Soft, absorbent, and strong disposable Corner Grommet Tee Towels.

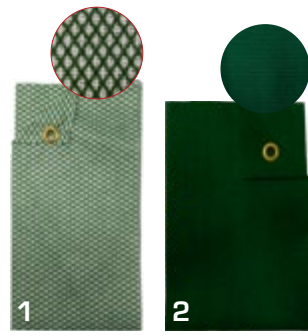

1. Classic Tee Towel [No. 728GR] *WQL
 200 towels/pkg
2. Premium Tee Towel [No. 729GR]
 100 towels/pkg

This Microfiber Dri-Lite Terry Towel is trifolded with grommet and hook, finished size of 5"x17.



Dye Sublimated Microfiber Dri Lite Terry Towel with Logo
 Towel can be customized to any color. *Contact us for details and pricing.*

WATER COOLERS

The Igloo water coolers are easy to transport and are made of sturdy, heavy-duty plastic. The inner layer is insulated which keeps liquids cool longer, even on hot days.



10 Gal. Water Cooler [No. 282G]
 Replacement liners available [No. T1000 - 50/box]; not included, sold separately



5 Gal. Water Cooler [No. 281]

TEE BOX AREA

BENCHES

All benches made with 2"x6" ultraplast recycled plastic for longevity and durability. Ships flat for economy and convenience. All necessary hardware included.



Grey Redwood Green



Grey Redwood Green



Grey Redwood Green



Tan



Tan



Tan

5' Deco Bench

Grey [No. EE1170]
 Redwood [No. EE1179]
 Green [No. EE1174]
 Tan [No. EE1178]

6' Deco Bench

Grey [No. EE1190]
 Redwood [No. EE1193]
 Green [No. EE1194]
 Tan [No. EE1198]

6' Standard Bench

Grey [No. EE1210]
 Redwood [No. EE1213]
 Green [No. EE1214]
 Tan [No. EE1218]

WATER COOLER ACCESSORIES

All accessories made of premium material. Easy to install and replace any broken parts. Sold individually. Some assembly required.

Dispensers can hold approx. 200 solo cups* at a time. They come complete with a mounting bracket that attaches easily to our water coolers.

*Sold separately



1. Lock and Key [No. 282C]
2. Plastic Bracket [No. 282CLIP]
3. Steel Bracket [No. 279-4]



4. Lever Style Spigot [No. 282]
5. Pinch Tube Spigot [No. T600]
6. Push Button Spigot [No. 282SPIG]



7. Steel Cup Dispenser [No. 283]
8. Plastic Cup Dispenser [No. 283P]
9. 4 oz Solo Cups [No. 288]
 Sold in cases of 5,000 only.

TEE BOX AREA

BROKEN TEE CADDIES

They act as distance markers and as receptacles for broken tees.

Made of durable plastic material and color impregnated through allows for an economical and lasting tee caddy. Stainless steel spike included.



Plastic Broken Tee Caddy [No. 815]

Measures H: 6" (without spike)
W: 5" Diameter

- Red ○ White
- Blue ● Yellow



- *Custom colors are available.
- Red ○ White ● Blue
 - Yellow ● Green ● Black

Aluminum Broken Tee Caddy [No. 808]

Made of cast aluminum and powder coated. 3.5" SS spike included.
Raw/Unfinished Caddies are available.
Measures H: 4.5" (without spike)
W: 5.5" Diameter



Made of recycled plastic lumber, this caddy has a steel mesh base for drainage.

Recycled Plastic Broken Tee Caddy [No. E803GR]

Measures (HxWxL): 3.5"x6.75"x10"

TEE BOX AREA



Tear Drop Marker
Part No. 816WH
CUSTOMIZE WITH A DECAL!

ALUMINUM TEE MARKERS

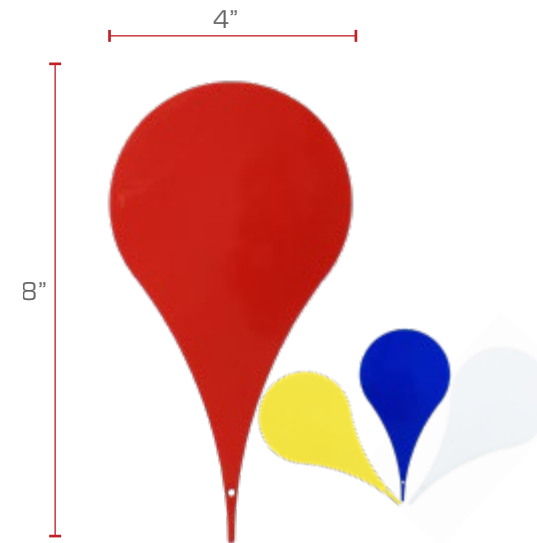

- Red ○ White ● Blue ● Yellow

Made of 1/8" thick steel with powder coated finish. Custom decals and colors are available.

Tear Drop Tee Marker [No. 816]

Raw/Unfinished Markers are available.
Custom decal available - Call for quote.



- Red ○ White ● Blue
- Yellow ● Green ● Black

Made of aluminum with powder coated finish. Each marker comes complete with a stainless steel spike.

Solid Aluminum Tee Marker [No. 820]

Raw/Unfinished Markers are available.
*Custom colors are available.

PLASTIC TEE MARKERS

These markers are made of durable polyethylene plastic material. The color is impregnated for longevity. Each marker is completed with a metal spike.



- Red
- White
- Blue
- Black
- Yellow

3" Solid Plastic Tee Marker [No. 810]



- Red
- White
- Blue
- Yellow
- Black
- Gold

5" Solid Plastic Tee Marker [No. 812]



- Red
- White
- Blue
- Yellow
- Black

5" Hollow Plastic Tee Marker [No. 811]



Our 5" hollow plastic tee marker, but with molded in plastic base.

- Red
- White
- Blue
- Yellow
- Black

5" Hollow Tee Marker w/ Plastic Base [No. 814]



Made of recycled plastic, this solid cube marker measures 4"x4"x4" and comes complete with a steel spike.

- Green
- Red
- White
- Blue
- Yellow
- Black

Recycled Plastic Cube Tee Markers [No. E800]



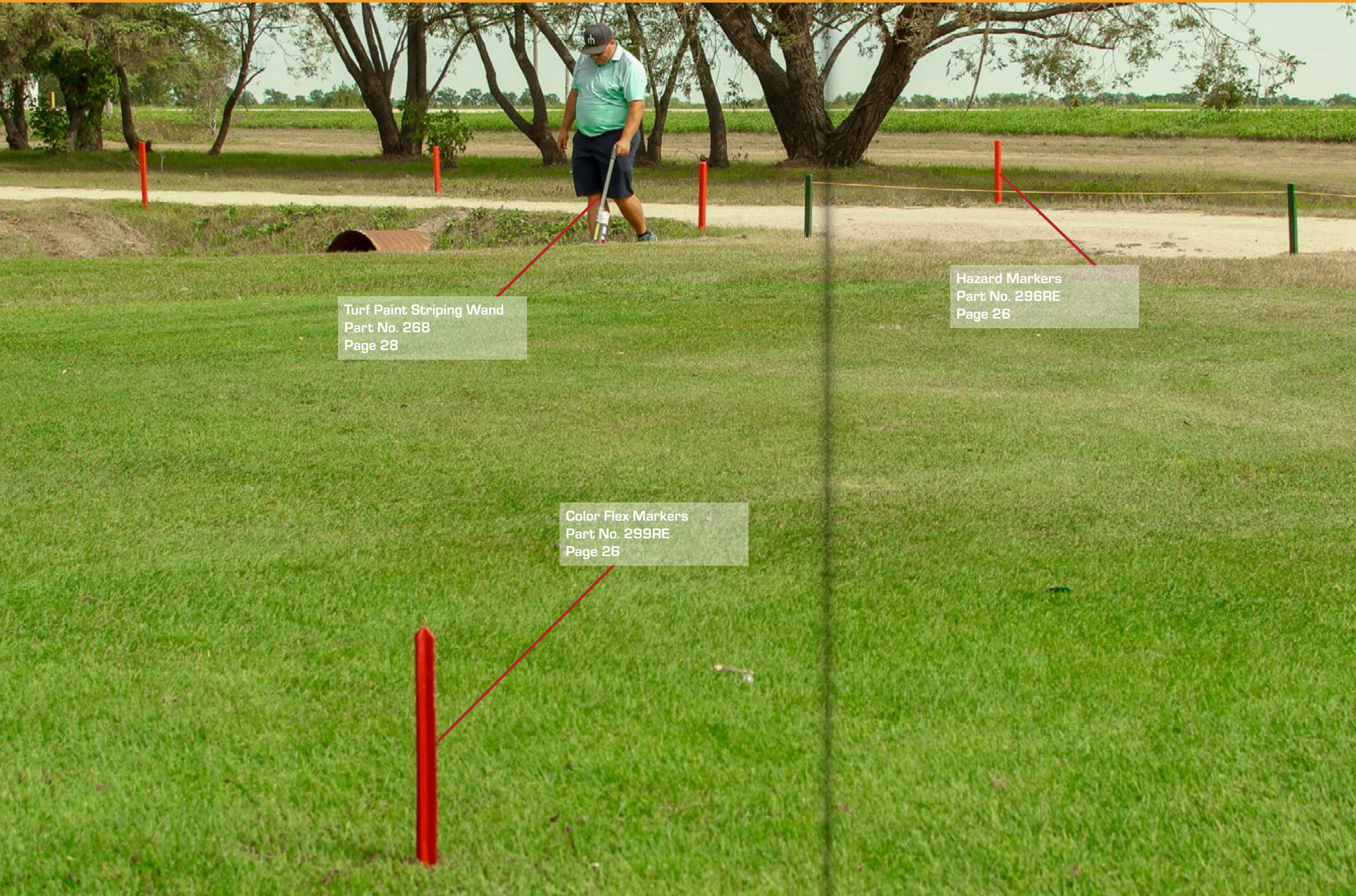

Turf Paint Striping Wand
Part No. 268
Page 28

Hazard Markers
Part No. 296RE
Page 26

Color Flex Markers
Part No. 299RE
Page 26

| | |
|--------------------------|----|
| COLOR FLEX MARKERS | 26 |
| FAIRWAY DISTANCE MARKERS | 26 |
| HAZARD MARKERS | 26 |
| ROPE STAKES | 27 |
| BRAIDED & BUNGEE ROPE | 27 |
| PAINT AND MARKING TOOLS | 28 |

COLOR-FLEX DISTANCE MARKERS

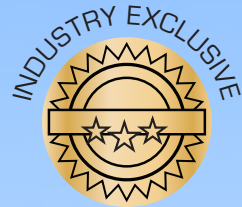

- HIGHLY VISIBLE, NON INTRUSIVE, PERMANENTLY COLORED STAKES
- SUPREME DURABILITY AND RESILIENCE IN EXTREME TEMPERATURE CHANGES
 - THE **ONLY** FLEXIBLE DISTANCE MARKERS
- WITHSTANDS CROSS CUT OR DIAGONAL MOWING IN **ANY** DIRECTION
 - SPEEDS UP GAME PLAY AND MOWING TIMES
 - EASY 2-STEP INSTALLATION
 - 6 MONTHS WARRANTY
- REPLACEMENT MARKERS AND INSTALLATION KITS ARE AVAILABLE



Step 1: Continue mowing without getting off to take out the markers.
Step 2: There is no step 2.



COLOR FLEX MARKERS

The ColorFlex Fairway Distance Marker is an industry exclusive item that was designed to eliminate the removal of markers while mowing - one of the most bothersome tasks for superintendents. Speed up your mowing times by simply mowing over them.

- Blue
- White
- Red
- Yellow
- Green
- Orange
- Silver

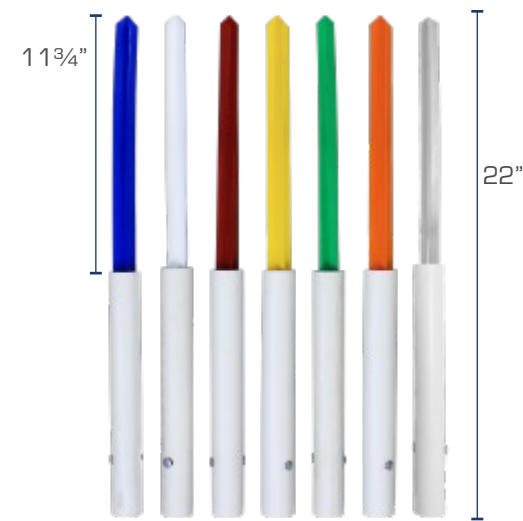

Color Flex Distance Markers [No. 299]

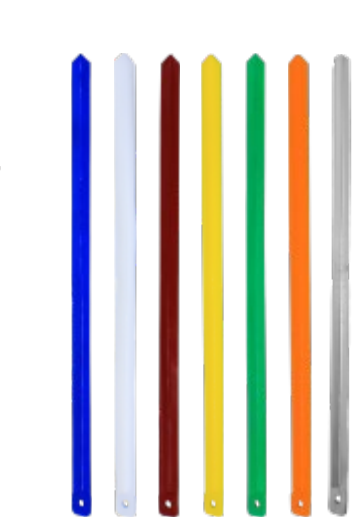

Replacement Markers [No. 299-01]

The kit includes everything you would need to install your ColorFlex markers quick and effortlessly. Sold separately, as well.



Installation Kit [No. 299KIT]

- Rubber Mallet [No. 299MAL]
- Drill Bit [No. 299BIT]
- PVC Tube Extension [No. 299TUBE]

FAIRWAY DISTANCE AND HAZARD MARKERS

Cast aluminum distance marker with a powder coated finish. Comes complete with a 6" stainless steel spike.

Made of heavy duty polymer, these domed distance markers come complete with a 6" stainless steel spike.

- Red
- Blue
- Black
- White
- Yellow



Domed Aluminum Distance Marker [No. 573]



Domed Polymer Distance Marker [No. 571]

Appropriately color coded for OB (white) & water (red & yellow) hazards to reference areas on the golf course. Can also be used as distance markers. Size: 24"

- Red
- White
- Blue
- Yellow



Recycled Plastic Hazard Markers [No. 296]

ROPE STAKES

Choose a size (30" or 36") and the amount/ location of speed slots. Comes in green. (Other colors and sizes are available upon request).

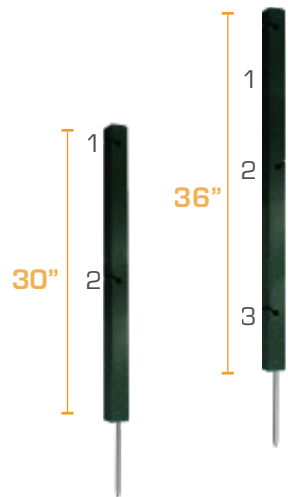

Custom Rope Stake [No. 289-CUSTOM]

8" marker made from recycled plastic with a stainless steel spike, featuring a 3.5" cap and 3.5" spike. Sold in packs of 25 with a storage bucket, available in various colors. Perfect for directing traffic on the golf course.



- Stake Colors:**
- Black
 - Green
 - Red
 - Brown
 - White
 - Blue
 - Yellow
- Cap Colors:**
- Black
 - Green
 - Red
 - Orange
 - Blue
 - Yellow

Directional Stakes [No. 290XX-XX]
290STAKE COLOR-CAP COLOR
(e.g., For a white stake with a green cap, use 290WH-GR).

Made of recycled color impregnated plastic with stainless steel spike.
Speed slot - 5mm, drilled hole - 12mm

- Black
- Green
- Red
- White
- Blue
- Yellow
- Brown



Recycled Plastic Rope Stakes [No. 289]

| Length | Item Number |
|--------|-------------|
| 15" | 289-15 |
| 18" | 289-18 |
| 24" | 289-24 |

BRAIDED ROPE

Made of durable polypropylene material, this braided rope is 1/4" in diameter, waterproof and resists rot, oil and other chemicals. Hollow braid is super flexible with a smooth diamond weave.

- White/Green
- Yellow
- Green
- White
- Black



Three Strand Braided Rope [No. 287]
Available length: 1000 ft spools

BUNGEE ROPE

Made of quality flexible material that maintains elasticity even in cold climates and prevents the pulling out of the stakes if encountered. The rope remains taut and will not sag.

- Yellow
- White/Green
- Green
- Black



Bungee Rope [No. 400]
Available lengths: 250 ft and 500 ft
250 ft spool [No. 400-250]
500 ft spool [No. 400-500]

PAINT AND MARKING TOOLS

No more bending, simply insert the turf paint in the wand, point towards the ground and start walking. The wheel on the bottom allows for smooth glide without stopping or jerking. Applying straight lines has never been easier!



Marking Wand [No. 268]

A handheld alternative to the marking wand. Makes marking easier and keeps hands clean of paint. Perfect for out of reach areas.



Marking Pistol [No. 269]

Mark hazards, out-of-bounds lines & grounds repairs with a bright and vivid, fast drying solution. A hole-in-one for coverage, value, and performance!



Rust-Oleum Precision Line Marking Paint [No. 271]

Sold in cases of 12. Other colors are available upon request.

WE GO THE DISTANCE

590'-765' RUST-OLEUM

129'-222' BRAND 1

279'-442' BRAND 2

436'-530' BRAND 3

TRUSTED QUALITY SINCE 1921
RUST-OLEUM
INDUSTRIAL BRANDS

Rust-Oleum Precision Line marking paint for easy-to-read, bright, vivid markings with no mess. Marks more linear feet than other brands.



Aluminum Cup Setter
Part No. 205
Page 35

Lever Extraction Hole Cutter
Part No. 222
Page 31

1 Pronged Cup Puller
Part No. 210
Page 32

| | |
|---------------------------|----|
| HOLE CUTTERS | 31 |
| CUP PULLERS | 32 |
| TRIMMERS | 32 |
| HOLE-IN-WHITE PAINT | 32 |
| ALUMINUM & PLASTIC CUPS | 33 |
| CUP LINERS | 34 |
| ALUMINUM PRO-HOLE CUPS | 34 |
| CUP ACCESSORIES | 35 |
| WHITE PLASTIC CUP COLLAR | 36 |
| CUP SLEEVES | 36 |
| REGULATION 1/2" POLES | 37 |
| TOURNAMENT 3/4" POLES | 38 |
| REGULATION SMARTY STICKS | 39 |
| WOODGRAIN 1/2" FLAG POLE | 39 |
| TOURNAMENT SMARTY STICKS | 40 |
| HARDWOOD 3/4" POLES | 40 |
| REFLECTORS | 41 |
| FLAGPOLE RESTORATION | 41 |
| COURSE & SPECIALITY FLAGS | 43 |
| FLAG ACCESSORIES | 43 |
| RAKE HEADS | 45 |
| RAKE HANDLES | 45 |
| COMPLETE RAKES | 45 |
| COCO DRAG MAT | 46 |
| GREENS TOOLS | 46 |
| BALL MARK REPAIR TOOL | 46 |

HOLE CUTTERS

The hole cutters are primarily made of aluminum alloy, making them durable and strong but light. They each come with either scalloped or straight blade.

Wider hole cutter that cuts a 6" wide hole. Perfect for the Temporary Cup No. 256



Lever Style Hole Cutter

Scalloped [No. 222] Straight [No. 223]
Easy to use lever for a quick hole extraction.

Lever Style Hole Cutter

Straight [No. 224] Scalloped [No. 225]
A classic hole cutter with shoe platforms on either side and a fixated handle.

Wide Hole Cutter [No. 219]

A hole cutter for 6" wide temporary cup for special events.

REPLACEMENT BLADES

Heat treated cutting blades ensure a clean cut hole. Available as scalloped and straight blade with an inside edge (for sandy and USGA soil) or an outside edge (for push-up greens and native soil).



1. Inside Edge Scalloped Blade [No. 220-IN]
2. Outside Edge Scalloped Blade [No. 220-OUT]

3. Inside Edge Straight Blade [No. 221-IN]
4. Outside Edge Straight Blade [No. 221-OUT]

HOLE CUTTER ACCESSORIES

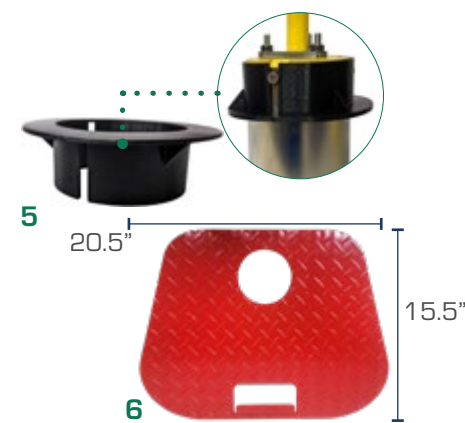

5. Hole Cutter Flanged Stop [No. 217]
Adjustable flanged stop ensures proper hole depth every time.

6. Red Hole Cutter Guide [No. 230]
Cast aluminum and powder coated, prevents scuffs and marks on the greens by the operator.

CUP PULLERS

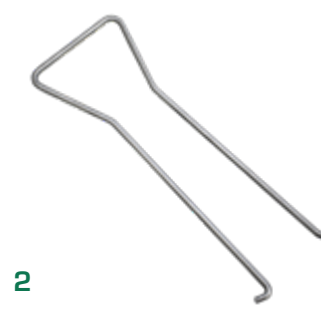

1. Single Prong Cup Puller [No. 210]

Powder coated white with a red rubber handle for comfort.
Size: approx. 6"
Works on all cups.

2. Double Prong Cup Puller [No. 206]

Made of durable aluminum; Pinch and release, then pull out the cup.
Size: approx. 8"
Works on all cups.

3. Three Prong Cup Puller [No. 200]

Zinc plated steel with a red rubber handle; Place, twist and pull to remove the cup.
Size: approx. 24"
Works only on 250AL cups.

TRIMMERS



Curved Trimming Scissors [No. 211]

Superior quality scissors, constructed from forged Stainless Steel. Comes complete with a dedicated plastic carry wallet. The curved design makes it easier to neaten the edges of freshly cut holes.

ALUMINUM CUPS

These cups are die cast oversize, then machined down to precise dimensions to minimize wobble in the hole. The aluminum cups are anodized then powder coated a bright white for best corrosion protection. Meets all USGA requirements.

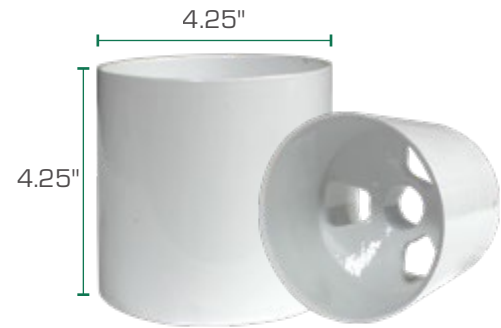

Aluminum Greens Cup (4.25"x4.25")
[No. 252AL]



Aluminum Green Cup (6"x4.25")
[No. 250AL]

PLASTIC CUPS

Made of durable, chemical resistant polymer material and meets all USGA regulations.

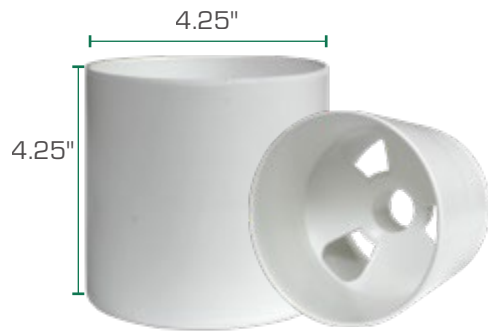

Plastic Greens Cup (4.25"x4.25")
[No. 255PL]



Plastic Greens Cup (6"x4.25")
[No. 250PL]



Plastic Cup with Bronze Insert (6"x4.25")
[No. 250PL/BZ]

Bronze bushing made of certified bearing bronze withstands abrasion and prevents sticking, extending the life of your cup.

ALUMINUM PRO-HOLE CUPS

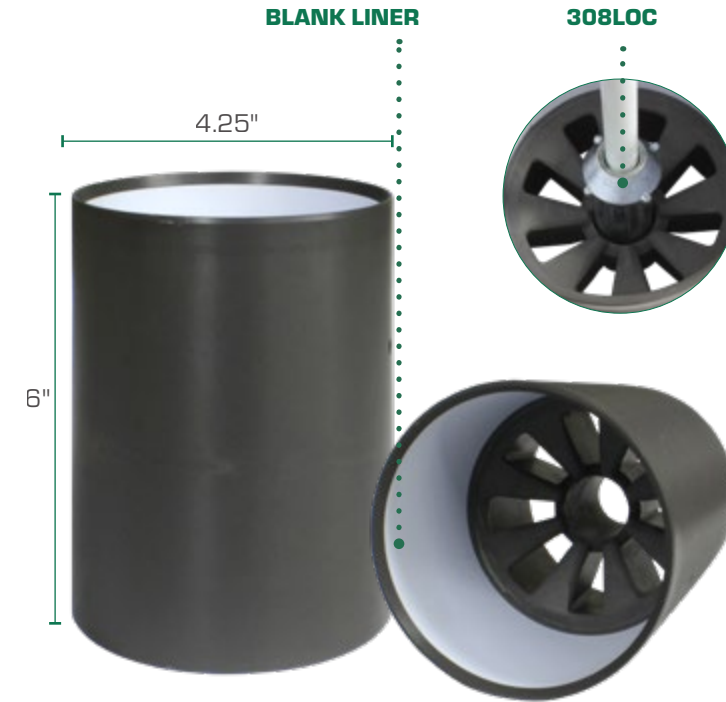

Pro Hole Cups are designed and finished to precise measurements, resulting in a world class greens cup. Completed with locking ferrule system that ensures unnecessary premature wear of the flag pole ferrule. Blank liner is included.

Aluminum Pro Hole Cup [No. 253AL-3]

This cup is made of durable heat treated aluminum alloy. Accepts British/locking [308LOC] ferrule to complete locking mechanism (pg. 37/38).

The standout feature of the 253AL-3 cup is its ability to print directly on the liner, making it an excellent option for special events and sponsorships.

CUP LINERS

SpeedWrap liners are thin, flat inserts that fit only in our pro hole cups. Fully customizable with a club logo or sponsor for increased revenue. The blank and specialized cup liners are in stock and ready for immediate shipping.

SpeedWrap Liners [No. 253]

Blank Cup Liner [No. 253L-4 or 253L-3]

Customize Your Liner [No. 253CUSTOM]
(Minimum order of 20)
Sold in two versions. Please contact us for custom liners and version inquiries.

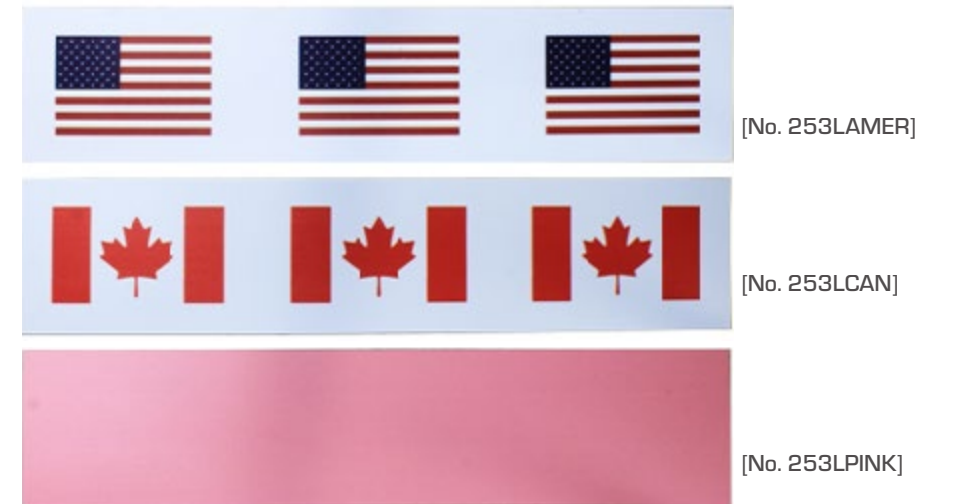

CUP ACCESSORIES



Cast aluminum cup setter consistently places cups at the correct depth, minimizing damage to the rims of aluminum cups and preventing ball interference.

Aluminum Cup Setter [No. 205]



Cover the putting green holes with this easy to install and remove cover. Made of durable plastic, it withstands pressure and weight.

Green Plastic Cup Cover [No. 262GR]



The perfect solution to stabilize a golf cup and keep it from pulling out of the hole. These 5x5" square, dense plastic plates with a grooved slot fit all of our plastic and aluminum cups (4.25" or 6" height). Add super Glue (not included) in the groove and press bottom of the cup into the slot and let dry.

Golf Cup Stabilizer [No. 263]

CUP ACCESSORIES

WHITE PLASTIC CUP COLLAR

A white plastic cup ring makes the hole more visible and gives the same effect as hole paint without the labor and clean up. Easy to install and keeps integrity of cup when changing holes daily. This also stabilizes soil around the top of the hole which prevents erosion.



White Plastic Cup Collar [No. 251]

Individual [No. 251]

10 Pack [No. 251-10]

20 Pack [No. 251-20]

CUP SLEEVES

Cup sleeves are used in the installation of artificial putting greens. Made from PVC plastic and machined for a perfect fit! The cup will sit 1/8" above the sleeve when installed.



Cup Sleeves [No. 259]

For 6" Cup (Plastic or Aluminum) [No. 259-6]

For 4" Cup (Plastic or Aluminum) [No. 259-4]

REGULATION 1/2" FIBERGLASS POLES

Our fiberglass poles are manufactured to the highest quality and appearance for excellent corrosion and weather ability. They are veil wrapped to increase lifespan and reduce splinters from fiberglass material.

- Top threaded bushing
- Color impregnated - color does not peel or fade with time
- Complete with a smooth ferrule and an acorn nut (other ferrules available)
- Suits the swivel of a grommet and tube style flags
- Ships with a sleeve on the bushing and ferrule for additional protection

Available Colors and Striping

| | 5' | 7' | 7.5' | 8' |
|--|--------|----------|------------|----------|
| | 300W-5 | 300W-7 | 300W-75 | 300W-8 |
| | 300Y-5 | 300Y-7 | 300Y-75 | 300Y-8 |
| | -- | 300BW-71 | 300BW-751 | 300BW-81 |
| | -- | 300YB-71 | 300YB-751 | 300YB-81 |
| | -- | -- | 300BW-752 | -- |
| | -- | -- | 300YB-752 | -- |
| | -- | -- | 300RW-752 | -- |
| | -- | -- | 300BLW-752 | -- |
| | -- | -- | 300PW-752 | -- |
| | -- | -- | 300GW-752 | -- |

**All other poles discontinued. Please see our website for available clearance stock on flagpoles.



Smooth Ferrule [No. 308SMO]



Slotted Ferrule [No. 308SLO]



Locking Ferrule [No. 308LOC]
Fits only our pro-hole cup (253AL-3).

TAPERED TOURNAMENT 3/4" FIBERGLASS POLES

Our fiberglass poles are manufactured to the highest quality and appearance for excellent corrosion and weather ability. They are veil wrapped to increase lifespan and reduce splinters from fiberglass material.

- Top threaded bushing
- Color impregnated - color does not peel or fade with time
- Complete with a smooth ferrule and an acorn nut (other ferrules available)
- Suits the swivel of a grommet and tube style flags
- Ships with a sleeve on the bushing and ferrule for additional protection

Available Colors and Striping

| | 7' | 7.5' | 8' | 10' |
|--|-----------|-------------|-----------|----------|
| | 300TW-7 | 300TW-75 | 300TW-8 | 300TW-10 |
| | 300TY-7 | 300TY-75 | 300TY-8 | 300TY-10 |
| | 300TBW-71 | 300TBW-751 | 300TBW-81 | -- |
| | 300TBY-71 | 300TBY-751 | 300TBY-81 | -- |
| | -- | 300TBW-752 | -- | -- |
| | -- | 300TBY-752 | -- | -- |
| | -- | 300TRW-752 | -- | -- |
| | -- | 300TBLW-752 | -- | -- |
| | -- | 300TPW-752 | -- | -- |
| | -- | 300TGW-752 | -- | -- |

**All other poles discontinued. Please see our website for available clearance stock on flagpoles.



Smooth Ferrule [No. 308SMO]



Slotted Ferrule [No. 308SLO]



Locking Ferrule [No. 308LOC]
Fits only our pro-hole cup (253AL-3).



TOURNAMENT POLE JOINER

*** 10 FT Tournament Poles Only***

Your 10-foot pole will arrive with the aluminum joiner pre-attached to one half of the pole, along with J-B Weld epoxy glue and assembly instructions. Assembly is required upon receipt to help reduce shipping costs.

REGULATION SMARTY STICKS

The six-eye prism 1/2" flagsticks provide 100% reflective coverage, making the poles faster and more accurate for all rangefinders. The prism reflectors are built directly into the pole, offering a discreet and efficient way to measure distance with a rangefinder.

Length: 7.5'

Other colors and striping is available.



| Item # | Description |
|--------------|-------------------------------|
| SS300W-75 | Solid White |
| SS300Y-75 | Solid Yellow |
| SS300BW-752 | White with Two Black Stripes |
| SS300BY-752 | Yellow with Two Black Stripes |
| SS300RW-752 | White with Two Red Stripes |
| SS300BLW-752 | White with Two Blue Stripes |
| SS300PW-752 | White with Two Pink Stripes |
| SS300GW-752 | White with Two Green Stripes |

Regulation Smarty Sticks [No. SS300]

FIBERGLASS WOODGRAIN REGULATION FLAG POLE



Our 1/2" Fiberglass Woodgrain Flag Pole is an inexpensive option to achieve the woodgrain look. The realistic woodgrain look provides a classic, natural look. Available in only 7.5 Ft.

Ferrule Options:



Fiberglass Woodgrain 1/2" Flag Pole [No. 300WOOD-75]

TOURNAMENT SMARTY STICKS

The six-eye prism 3/4" flagsticks provide 100% reflective coverage, making the poles faster and more accurate for all rangefinders. The prism reflectors are built directly into the pole, offering a discreet and efficient way to measure distance with a rangefinder.

Length: 7.5'

Other colors and striping is available.



| Item # | Description |
|---------------|-------------------------------|
| SS300TW-75 | Solid White |
| SS300TY-75 | Solid Yellow |
| SS300TBW-752 | White with Two Black Stripes |
| SS300TBY-752 | Yellow with Two Black Stripes |
| SS300TRW-752 | White with Two Red Stripes |
| SS300TBLW-752 | White with Two Blue Stripes |
| SS300TPW-752 | White with Two Pink Stripes |
| SS300TGW-752 | White with Two Green Stripes |

Tournament Smarty Sticks [No. SS300T]

HARDWOOD TOURNAMENT FLAG POLES



Introducing our new 1" Brazilian IPE hardwood flagstick, known for its exceptional durability—eight times harder than California Redwood. Naturally resistant to rot and decay, this flagstick is built to last. To enhance its longevity, our IPE is treated with multiple coats of marine-grade varnish for added protection.

*Only available in 7.5 Ft.

Ferrule Options:



Hardwood Tournament Flag Pole [No. 300TWOOD-75]

REFLECTORS

Easy to screw on top of any flag stick. Made with brass bushing to avoid premature wear of the threads. Sold individually.



Smarty Reflector - Six Eyed [No. 304-6BK]

Easy to screw on top of any flag stick. Made of specially formulated, soft polyurethane cylinder protects greens from flag swivel denting when dropped. Sold individually.



Elite Laser Reflector [No. 303-ELITE]

FLAGPOLE RESTORATION

An economical and easy way to re-new and protect splintered, cracked, faded, scratched, or dirty poles. Quickly applies with heat gun and will last for years. Fits tournament and regulation poles.



Bayco Guard for Flag Poles
250' Roll for 1/2" Pole [No. 3112]
250' Roll for 3/4" Pole [No. 3134]

Full 360° visibility, no dead spots, made of highly reflective material with a large surface area. Made for both 1/2" and 3/4" poles. Sold individually or in sets of 9.



Includes 2 grommets per reflector [No. 700-80]

Bayco Laser Reflectors
1/2" Opening [No. 3012]
Set of 9 [No. 3012-9]
1/4" Opening [No. 3034]
Set of 9 [No. 3034-9]

Make your own laser reflectors! Easy to install on your existing flag poles by heat shrinking the plastic provided on top of the reflector. It fits any pole of 1" or less in diameter. Sold only in sets of 9.



DIY Laser Reflector [No. 3000-9]

An easy to install ball lifter. Reduces bending and golfer-pole interaction. No need to remove the ferrule upon installation. 360° ball entrance with no interference. Fits regulation (1/2") and tournament (3/4") poles. All necessary hardware included.

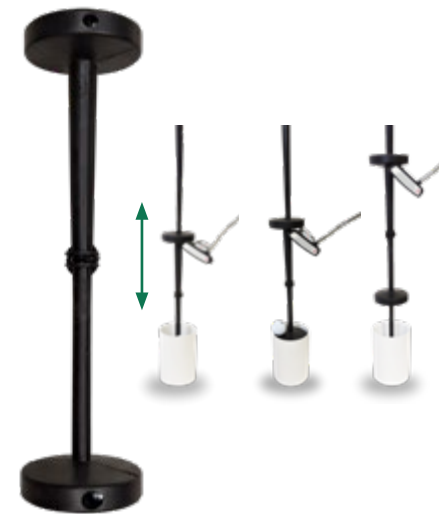

Mully Cup Lifter [No. 319-01]

FLAGPOLE HOLDERS

Kit includes a holder, a Canadian or American 14x20" Regulation flag; an acorn nut and top bushing; and a 3' white regulation pole. No ferrule required. Flag pole holder mounts directly to your choice of surface (wall, ground or other).



Flag Pole Holder Kit - American [No. 345AMER]



Flag Pole Holder Kit - Canadian [No. 345CAN]

Flag pole holder mounts directly to your choice of surface. Holds 1/2" poles only.

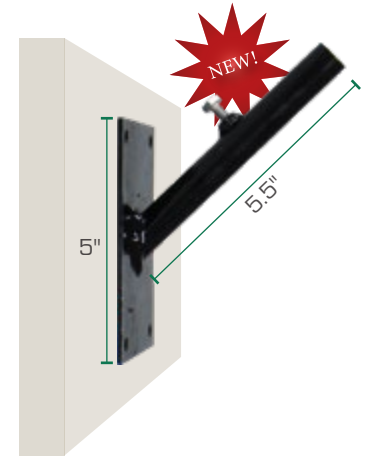

Flag Pole Holder Only [No. 345]

Our Universal Flag Holder allows you to attach a flag to virtually any cart. It features a 2' white pole and either a 6x8" (DS) or 14x20" (SS) handicap flag.



Universal Flag Holder with Flag
6x8" Handicap Flag [No. 346HDCP-1]
14x20" Handicap Flag [No. 346HDCP-2]
6X8" Canadian Flag [No. 346CAN]
6X8" American Flag [346AMER]



Other flags can be attached, as well.

Would you like a different pole or flag? Purchase the holder only and/or the rod only separately. Please contact us for more information.



1. Rod Only [No. 346ROD]
2. Universal Holder Only [No. 346]

COURSE FLAGS

All of our course flags are made of durable, quality, 400 Denier Solar Max material* complete with a tube locking attachment.

- Red
 - Yellow
 - Emerald Green
 - Pink
 - White
 - Orange
 - Light Blue
 - Hunter Green**
 - Royal Blue
 - Purple
 - Brown
 - Black
- *Custom colors available. **WQL

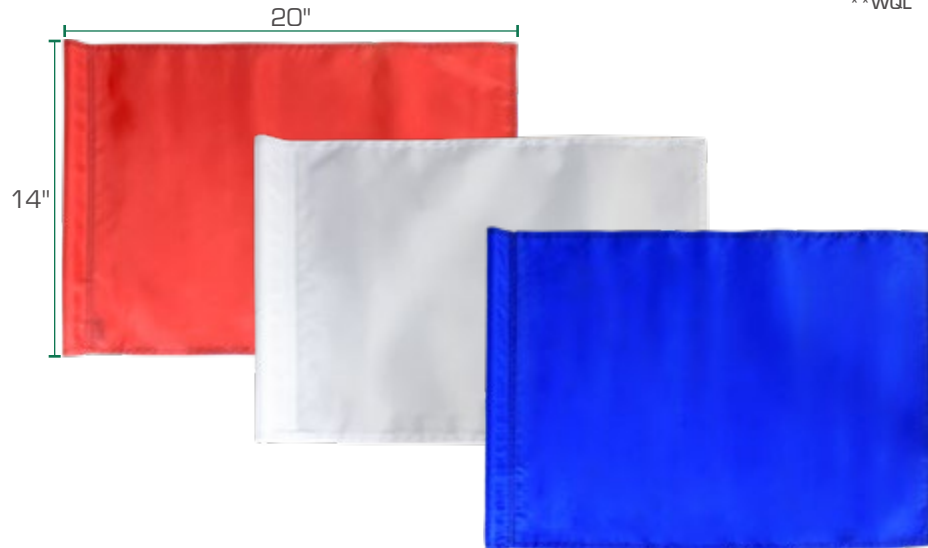

14x20" Nylon Solid Color Tube Flag [No. 1005T]

SPECIALTY FLAGS

Made of double sided Poplin material and dye sublimated for added durability, making them less vulnerable to fading and eliminating peeling. They come complete with a tube locking attachment.



14x20" American Flag [No. 1005AMERT] 14x20" Canadian Flag [No. 1005CANT]

FLAG ACCESSORIES



1. Quick Click [No. 316PL]

Removes the need for tools to change the flags. Works only with Bayco Tube Flags. Available as set of 9 [No. 316PL-9]

2. Security Nut [No. 1005NUT]

Secures flags onto flag poles and prevents theft. Slim enough to be used with or without the Acorn Nut.

3. Acorn Nut [No. 1005-3BK]



14x20" Ranger Flag [No. 1005RANT]



14x20" Marshall Flag [No. 1005MART]

NUMBERED FLAGS

Our numbered flags are made of Dura material and are dye sublimated*. Complete with a tube locking attachment. *Custom colors available.

- White/Black #'s
- Green/White #'s
- Red/Black #'s
- Black/White #'s
- Yellow/Black #'s
- Blue/White #'s
- Red/White #'s



14x20" Numbered Tube Flag [No. 1007T]

Sold only in sets of 1-9 or 10-18.

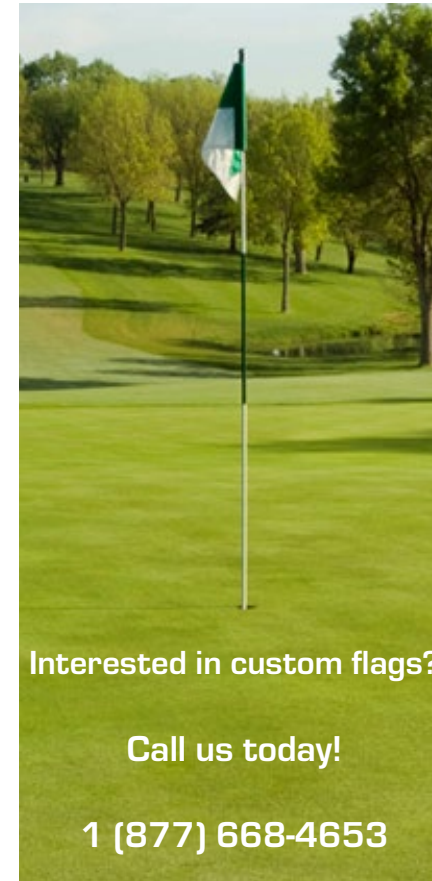

STOCKED SPECIAL EVENT FLAGS

Our special event flags are crafted from double-sided Poplin material and feature dye-sublimated graphics. Each flag comes with a tube lock attachment.



14x20" Awareness Flag [No. 1005BCAT] 14x20" Revenge Flag [No. 1005REVT]

CHECKERED FLAGS

Our checkered flags are made of Dura material and are dye sublimated*. Complete with a tube locking attachment.

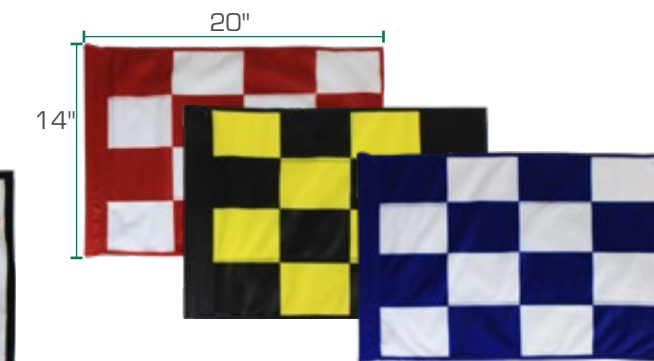

14x20" Checkered Tube Flag [No. 1005CHT]

- White/White
- Blue/White
- Red/White
- Green/White
- Yellow/White
- Black/White

*Custom colors available.

RAKE HEADS

Our rake heads are made of durable, lightweight plastic that is easy to use and carry. They spread sand evenly, leaving a consistent playing surface with minimal difference in grooves.



Lightweight Rake Head
21" [No. 102BK]; 15" [No. 105BK]



Octagon Rake Head
24" [No. 164BK]; 15" [No. 151BK]



Disc Tooth Rake Head
Available only in 16" [No. 161BK]

RAKE HANDLES



Yellow Wooden Handle
Available only in 48" [No. 106YE-48]



Green Fiberglass Handle
51" [No. 152GR-51]
72" [No. 152GR-72]



Yellow Fiberglass Handle
51" [No. 152YE-51]
72" [No. 152YE-72]



Brown Fiberglass Handle
Available in 51" [No. 152BR-51]
Available in 72" [No. 152BR-72]

BACK IN STOCK



Green Cart Fiberglass Handle*
42" [No. 152GR-42]
51" [No. 152GR-CART]

* Other colors and sizes available upon request.



Armored Rake Handle
51" [No. 152GR-51/A]

* Better grip, prevents splintering *

BAYCO SHRINK GUARD FOR RAKE HANDLES

No more fiberglass splinters from your rake handles. An economical and easy way to re-new your rakes and protect splintered, cracked, faded, scratched, dirty fiberglass handles. Quickly applies with heat gun and will last for years. *Heat sensitive material, exposure to temperatures over 90F (32C) may cause premature shrinkage.*



125' Roll | 140BK-125
250' Roll | 140BK-250



125' Roll | 140GR-125
250' Roll | 140GR-250



125' Roll | 140YE-125
250' Roll | 140YE-250

COMPLETE RAKES

| Lightweight Rake | 15" Head | 21" Head |
|----------------------|----------|----------|
| 48" Wooden Handle | 100PO | 125YE |
| 51" Green FG Handle | 118GR | 125GR |
| 51" Yellow FG Handle | 118YE | 126YE |

| Octagon Rake | 15" Head | 24" Head |
|-----------------------|------------|----------|
| 51" Green FG Handle | 150GR | 166GR |
| 51" Yellow FG Handle | 150YE | 166YE |
| 72" Green FG Handle | 150-72G | 165GR |
| 72" Yellow FG Handle | 150YE/72 | 165YE |
| 42" Green Cart Handle | 150GR/CART | 166YE |

| Disc Tooth Rake | 16" Head |
|-----------------------|------------|
| 51" Green FG Handle | 160GR |
| 51" Yellow FG Handle | 160YE |
| 72" Green FG Handle | 160GR/72 |
| 72" Yellow FG Handle | 160YE/72 |
| 42" Green Cart Handle | 160GR/CART |

COCO DRAG MAT

Made of natural fiber that will not damage, burn, or bruise tender grass. The fibers offer superb broom action, making it perfect for top dressing and filling aerated holes. Complete with a tow bar and a chain for easy attachment.

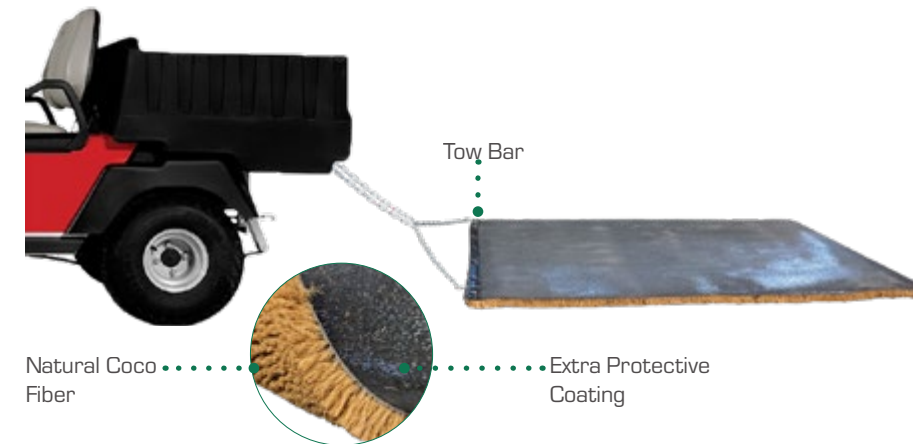

Natural Coco Fiber Extra Protective Coating

Bayco Golf Coco Drag Mat

6' x 4' Coco Mat [No. 247-6x4]

Topdressing keeps the greens healthy by breaking up organic matter and allowing more decomposition.

BALL MARK REPAIR TOOL

New and improved ball mark repair tool. No moving parts, one solid piece of aluminum with six blades forces grass and roots into damaged areas. Cap included. Length: 36"



InstaFix Repair Tool [No. 227-36]

GREENS TOOLS

Removes dew and other light debris from greens. The tip (8") slides inside the handle (8") during storage and transportation.



Dew Whipping Pole

Complete Unit [No. 280]
Replacement Rod [No. 280-2A]

Made of extruded aluminum alloy with a V-shaped groove extending along its length and a milled base to reduce bounce as the ball makes contact with the green surface. Length: 36"

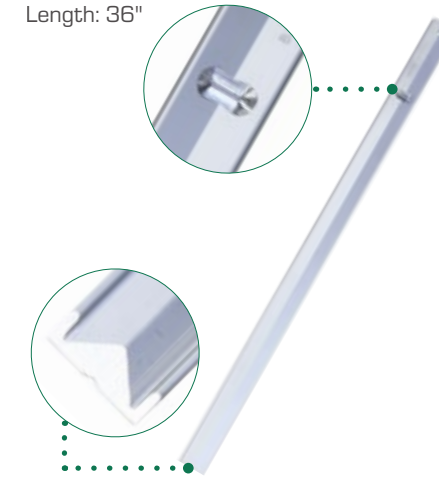

Bayco Golf Greens Speedmeter [No. 240]





| | |
|---------------------------------|----|
| CAST IN MOLD CUSTOM SIGNAGE | 49 |
| RECYCLED PLASTIC CUSTOM SIGNAGE | 51 |
| CAST IN MOLD GROUND TEE MARKERS | 52 |
| RECYCLED PLASTIC EASELS | 53 |
| SPONSOR SIGNAGE | 53 |
| ACP CUSTOM SIGNAGE | 54 |
| HEAVY DUTY SIGNAGE | 55 |
| ALUMINUM & DIRECTIONAL SIGNAGE | 56 |

COURSE SIGNAGE

COURSE SIGNAGE

CAST IN MOLD BRONZE AND ALUMINUM CUSTOM SIGNAGE

Our premium bronze and aluminum signage help identify each hole while bringing elegance to the course and adding to the golfer's experience.

STEP 1: Choose your shape
We offer 10 classic shapes for your sign.

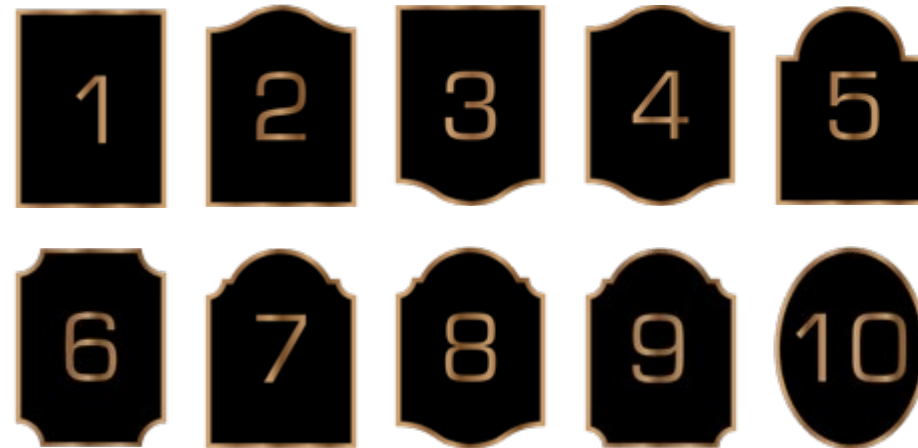

STEP 2: Choose your style
We offer three different styles to showcase information about your course.

All you need to provide us with is your course logo and hole information!

Note: If you choose Imperial, we would require artwork for the course holes, also.



SIGNATURE

- Course Logo
- Hole Number
- Par Number

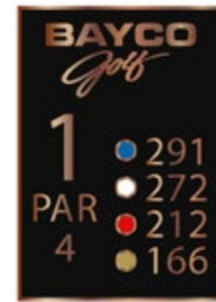

CLASSIC

- Course Logo
- Hole Number
- Par Number
- Tee Box Yardages
- Colored Dots (optional)



IMPERIAL

- Course Logo
- Hole Number
- Par Number
- Tee Box Yardages
- Colored Dots (optional)
- Hand-Painted Hole Map

STEP 3: Choose your size
Use the size chart to the right for the best size for the desired style.

| SIZE | SIGNATURE | CLASSIC | IMPERIAL |
|---------|-----------|---------|----------|
| 10"x16" | ✓ | | |
| 12"x14" | ✓ | | |
| 12"x18" | ✓ | ✓ | |
| 14"x20" | ✓ | ✓ | ✓ |
| 14"x22" | | ✓ | ✓ |
| 16"x22" | | ✓ | ✓ |
| 18"x24" | | | ✓ |

STEP 4: Customize your signage with finishing touches on the next page.

SIGNAGE CUSTOMIZATION OPTIONS

CAP OPTIONS



MOUNTING OPTIONS

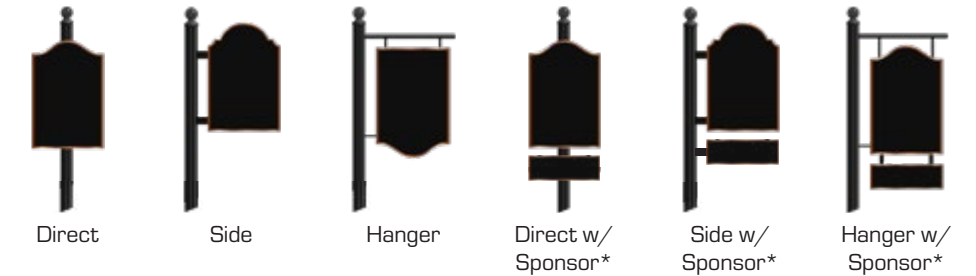

*More than one sponsor can be added.

PIPE OPTIONS



Posts are typically 3" but they are available in 4", as well.

POST BASE OPTIONS



Post bases can be mounted to a surface or they can come with an 24" extension pipe for direct burial.



With recycled plastic signs the possibilities are virtually endless. It is a superior, yet an economical, way to add first class signage to your facility.

STEP 1: Choose your shape from the ones shown or send us your idea.

RECYCLED PLASTIC CUSTOM SIGNAGE



STEP 2: Select the style and size. You can also choose between no border, single border, or double border.



We can fill the yardage dots with our durable resin!



SIGNATURE

- Course Logo
- Hole Number
- Par Number



CLASSIC

- Course Logo
- Hole Number
- Par Number
- Tee Box Yardages
- Colored Dots (optional)



IMPERIAL

- Course Logo
- Hole Number
- Par Number
- Tee Box Yardages
- Colored Dots (optional)
- Hand-Painted Hole Map

*Other sizes available.

SIZES*

- 15"x19"
- 18"x24"
- 24"x30"

STEP 3: Choose the color combination.

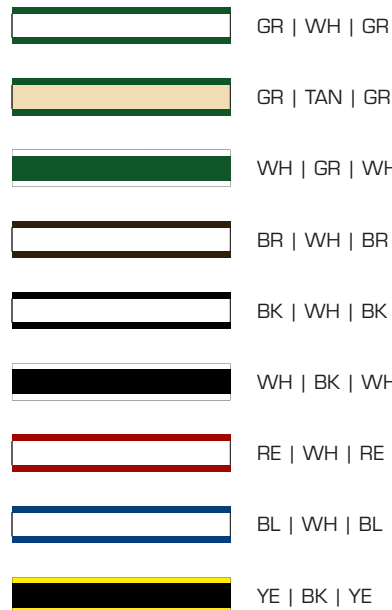

STEP 4: Select your logo style.

The **inset method**, your design is reverse printed onto a protective shield, then embedded into the sign and sealed with clear resin.



The **engraved method** allows for the design to be 'sunk' into the base. Your design is precisely engraved into the sign base, leaving it blank. You may choose to have it filled with our special resin.



In-ground yardage markers properly mark the course which speeds up the pace of play. They come complete with two spikes to keep them in place. Available in bronze or aluminum.

CAST IN MOLD BRONZE AND ALUMINUM GROUND TEE MARKERS

Display your brands/logos or sponsors across the facility. These signs leave a long lasting impression. All you need to provide us with is the artwork of your chosen logo/sponsor and we will do the rest.

Can't find what you're looking for? We can customize your project further! Call to inquire today!

STEP 1: Choose your shape.



OVAL

ROUND



RECTANGLE

SQUARE

STEP 2: Choose your size.

| SIZE |
|--------|
| 5"x3" |
| 6"x4" |
| 7"x5" |
| 8"x6" |
| 9"x7" |
| 10"x7" |
| 10"x8" |

| SIZE |
|---------|
| 5"x5" |
| 6"x6" |
| 7"x7" |
| 8"x8" |
| 10"x10" |
| 12"x12" |

STEP 3: Choose your border.



NO BORDER

BORDER



BROKEN BORDER

BEVELED BORDER

LOLLIPOP TEE MARKERS



These Lollipop Tee Markers feature built-in mounting spikes, ensuring easy and durable installation. They can be customized in various colors and with your logo. Available in both 5" single-sided and 5" double-sided options, and offered in bronze or aluminum finishes.

Please inquire for more details & pricing.

2 SPIKE TEE MARKERS



These tee markers come in a variety of shapes and can be customized in different colors with your logo. They are available in both bronze and aluminum.

Please inquire for more details & pricing.

Available Shapes:



Available Sizes:
4"x6" & 5"x7"

Available Sizes:
6"x4" & 7"x5"

Available Sizes:
5" & 6"

RECYCLED PLASTIC EASELS

| SIZE | CLOCK | YARDAGE |
|---------|-------|---------|
| 16"x24" | ✓ | ✓ |
| 22"x32" | | ✓ |

Made from 1/2" recycled plastic material with resin filled flags. Easily display important information for your golfers such as the golf time or the daily yardage. Available as single or double sided. The design features an aluminum hinge mount for easy transportation, storage, and assembly.



SPONSOR SIGNAGE



A perfect way to recognize sponsors at your special events and tournaments, these signs are fully customizable, available in single-sided or double-sided options, with no limit to the number of logos per sign. Made from durable corrugated plastic, they are mounted securely with double ground spikes for easy installation and stability. Available in 24"x16". Please inquire for more details & pricing.

ACP CUSTOM SIGNAGE

This economically priced sign is made from durable aluminum composite panel (ACP) material, featuring two 0.30mm aluminum sheets bonded to a solid polyethylene core. The design is printed directly onto the surface and then sealed with a protective clear coat, ensuring longevity and quality. Our customizable signs are perfect for golf courses, offering unlimited options for colors and border styles to suit your needs.

*An 8ft black aluminum sign post with cap is also available—please inquire for more details & pricing.



SIGNATURE
- Course Logo
- Hole Number
- Par Number



CLASSIC
- Course Logo
- Hole Number
- Par Number
- Tee Box Yardages
- Colored Dots (optional)



IMPERIAL
- Course Logo
- Hole Number
- Par Number
- Tee Box Yardages
- Colored Dots (optional)
- Hole Map



STEP 1:

Select your preferred color combination for the sign. The options are unlimited—contact us for more details.

STEP 2:

Choose the style and size of your sign, with options for no border, single border, or double border.

Available Sizes:

- 15"x19"
- 18"x24"
- 24"x30"

Custom sizes available upon request.

STEP 3:

Choose a regular tee sign layout or collaborate with us to design a custom one. The options are limitless!

Artwork is required for logos.

HEAVY DUTY SIGNAGE

Our Heavy Duty Metal Signs are produced from a single piece of 3mm metal with a powder coated finish. They come with single or double spikes and are available single or double sided. We have these signs with stock messages or we can design a custom message with your course logo. All messages are applied to signs using a pressure sensitive label, so the possibilities are virtually endless!



8"x6" Heavy Duty Steel Signs [No. 591]

Available stock messages:

Please Replace Divots
 Carts This Way →
 Carts This Way ←
 No Carts Beyond This Point
 Next Tee ←
 Next Tee →

[add -03]
 [add -06]
 [add -07]
 [add -08]
 [add -12]
 [add -13]

7"x12" Heavy Duty Steel Signs [No. 592]

Available stock messages (cont):

Keep carts off apron
 Keep carts 30 ft from greens
 Drop Area
 Please Repair Ball Marks

[add -14]
 [add -15]
 [add -17]
 [add -18]

*Simply add the extension number for the specific stock message. For example, "Drop Area" on an 8x6" would have an item number 591-17.

CUSTOMIZE YOUR OWN SIGN:

1. Choose your sign size (8x6" or 7x12")
2. Select single or double sided:
 - You may have the same message on both sides or different messages on either side.
3. Design your decal. As long as it fits on the sign, anything can be printed. Please contact us for more information.

Minimum order of 6.



ALUMINUM AND DIRECTIONAL SIGNAGE

Aluminum spikes come as one piece. Use with Aluminum Signs. Sold separately.

Aluminum Signs are produced from a single piece of 3mm metal with a powder coat finish. **Minimum order of 6.**

Made from high quality steel, with a powder coated finish and white lettering. One complete piece, eliminating the need for spikes. **Minimum order of 6.**

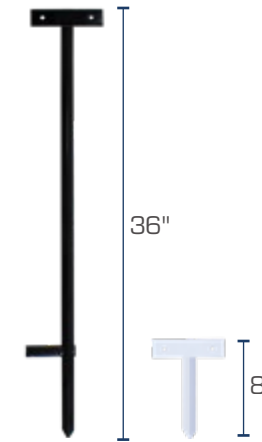

Aluminum Spikes for Customizable Signs

| Color | 36" Spike | 8" Spike |
|-------|-----------|----------|
| Black | 529BK | 500-1BK |
| White | 529WH | 500-1WH |

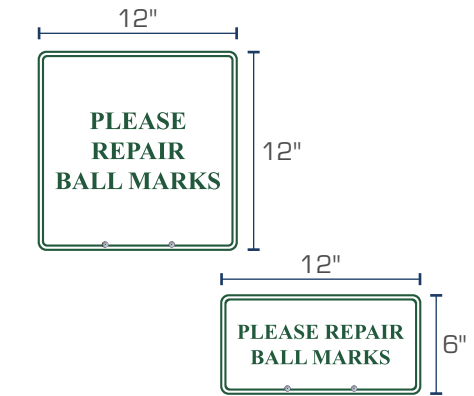

Customizable Aluminum Signs

| Stock Message | 12"x12" | 6"x12" |
|---------------------------|---------|--------|
| No golf carts beyond here | 500-10 | 528-10 |
| Carts in rough only | 500-11 | 528-11 |
| Chemicals applied today | 500-12 | 528-12 |
| No Carts Today | 500-13 | 528-13 |
| Please repair ball marks | 500-14 | 528-14 |
| Ground under repair | 500-15 | 528-15 |

Custom lettering & numbering available
 Inquire for more details.

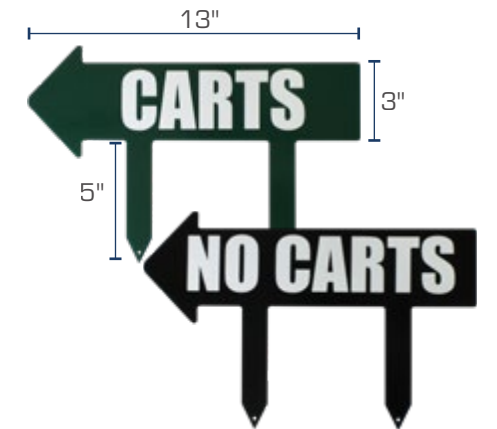

Two Sided Aluminum Directional Signs

| Stock Message | Green | Black |
|---------------|-------|-------|
| Plain Arrow | 540GR | 540BK |
| Next Tee | 541GR | 541BK |
| Carts | 542GR | 542BK |
| Golf Carts | 543GR | 543BK |
| 10 Tee | 544GR | 544BK |
| No Carts | 545GR | 545BK |

Custom lettering & numbering available
 Inquire for more details.





Sprinkler Head Trimmer
Part No. 208
Page 61

| | |
|-------------------------|----|
| SOIL SAMPLERS | 59 |
| AERATORS | 60 |
| SPRINKLER HEAD TRIMMERS | 61 |
| LANDSCAPERS & SQUEEGEES | 61 |
| OTHER MAINTENANCE TOOLS | 62 |

SOIL SAMPLERS

Soil samplers allow core samples to be taken for evaluation of soil composition and root growth or for subsequent soil analysis. It also helps determine the need for aeration and to select the proper fertilizer for root development.

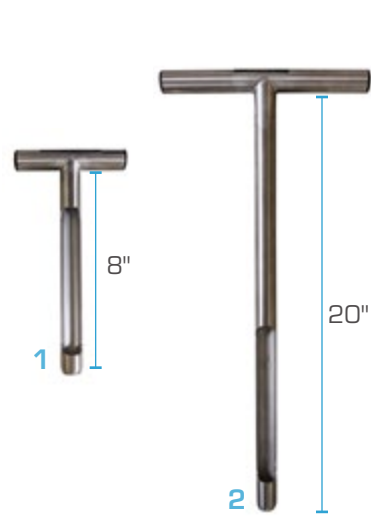

- 1. 8" Soil Sampler [No. 235-8]**
One piece rugged stainless steel pipe.
- 2. 20" Soil Sampler [No. 235]**
One piece rugged stainless steel pipe.

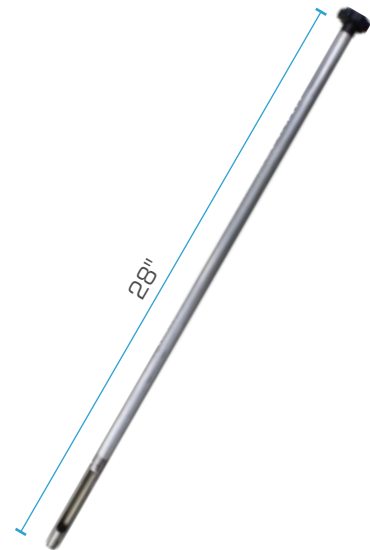

28" Greens Soil Sampler [No. 237]
Less intrusive, one piece rugged stainless steel pipe. Complete with a rubber handle for added comfort.



Greens Section Soil Sampler [No. 238]
This spade-like greens section soil sampler is tapered to give a clean cut and minimize surface disruption. The blade is then easily removed to examine the profile of the sample.



AERATORS

Made of heavy duty steel, these aerators are easy to use on those small and hard to reach spots on the greens that need immediate attention.



Three-Pronged Aerifier [No. 236]



Five-Pronged Aerifier [No. 239]



Fits our aerifiers. Sold in sets of three. Complete with holding pins.



Replacement Steel Tines [No. 236-1]

Why aeration is important?

Aeration is an essential practice that improves the long-term health and playability of golf courses. By using hollow tines to extract plugs, you can:

-  Ensure longevity of your course
-  Alleviate compaction
-  Remove layering

Long lasting benefits of aeration:

The following benefits can be observed when aeration is done seasonally and correctly:

-  Improves Water Infiltration
-  Oxygenates The Soil
-  Removes Thatch
-  Encourages Root Growth
-  Stimulates Microbial Activity
-  Promotes Recovery From Stress

SPRINKLER HEAD TRIMMERS

Sprinkler heads can easily become lost on the course and lead to negative impacts on the functionality of the irrigation system. These trimmers are easy to use and leave a clean edge around the sprinklers.

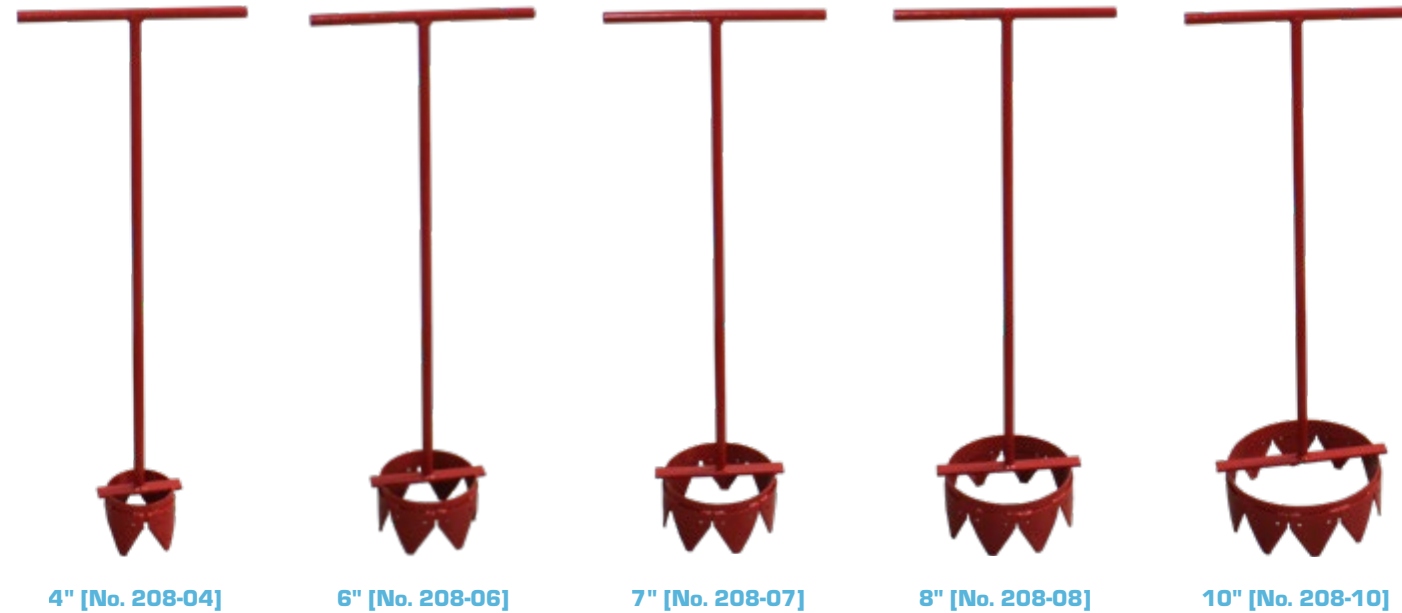

4" [No. 208-04]

6" [No. 208-06]

7" [No. 208-07]

8" [No. 208-08]

10" [No. 208-10]

LANDSCAPERS AND SQUEEGEES

This aluminum landscape rake is used for ground raking, smoothing, leveling, spreading, seeding & leaf clean-up. The heavy duty brace is all one piece and is riveted to the rake head.

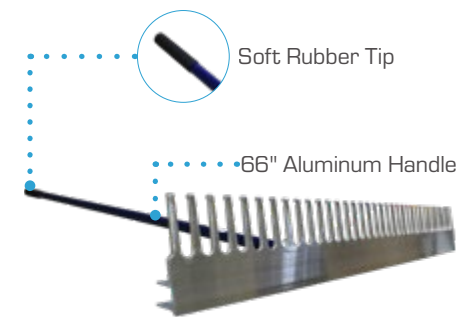

Aluminum Landscaper

| Head Length | Stock Code |
|-------------|------------|
| 24" | 114AL |
| 36" | 115AL |
| 48" | 116AL |

A squeegee roller made of industrial grade stainless steel axle and efficient non-absorbent rubber roller; effectively rolls collected water. Replacement heads available while quantities last.

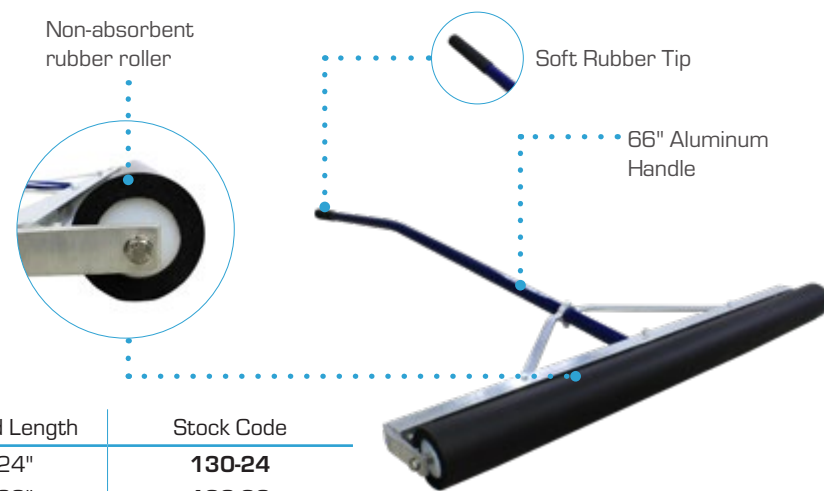

Non-Absorbent Roller Squeegee

| Head Length | Stock Code |
|-------------|------------|
| 24" | 130-24 |
| 36" | 130-36 |
| 48" | 130-48 |

OTHER MAINTENANCE TOOLS

Aluminum shaft with stainless steel grabbers that open to a 4.5" width. Capable of lifting up to 6 lb and sensitive enough to pick up a dime.



E-Z Reacher

32" Handle [No. EZR3200]

40" Handle [No. EZR4000]

72" Handle [No. EZR7200]



Light, heavy duty aluminum plug pusher will make cleaning up the golf course easy. It efficiently pushes plugs or moves and levels sand and loose material.

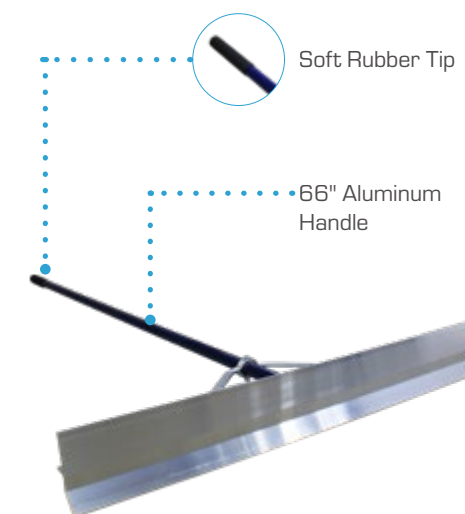

Aluminum Plug Pusher [No. 131]

Durable, dense polyethylene tank, easy to fill 4.25" opening, 28" wand, and chemically resistant seal. Capable of performing every spraying task.



SOLO Back Pack Sprayer [No. 190]



Range Club Washer
Part No. 695
Page 69

Recycled Plastic Bench
Part No. EE1214
Page 18

Medium Divot Mix Container
Part No. 696
Page 13

Bungee Rope
Part No. 400YE
Page 27

| | |
|-------------------------------|----|
| PRACTICE GREENS MARKERS | 65 |
| PRACTICE GREENS POLES & BASES | 66 |
| PRACTICE GREENS FLAGS | 67 |
| RANGE FLAGS | 68 |
| CHIPPING GREENS BALL PUSHER | 68 |
| RANGE CLUB WASHERS | 69 |
| CUSTOM RANGE DIVIDERS | 70 |
| RANGE BANNERS | 70 |

PRACTICE GREENS MARKERS

A 28" tall gimme marker with a 1/2" thick fiberglass rod and a cast aluminum head. The head can be customized with your own logo decal or a sponsor. (e.g., For a blank green gimme head use 264GR-BLANK).

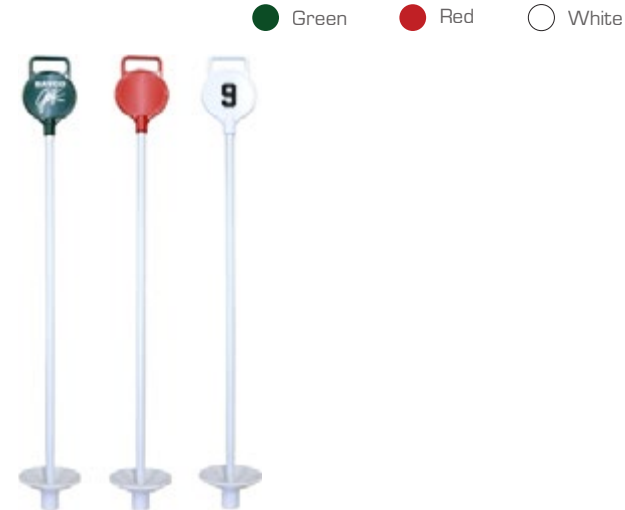

Gimme PG Markers w/ Plastic Base

| Decal: | Plastic Base |
|--------------|--------------|
| Blank | 264XX-BLANK |
| Set of 1-9 | 264XX-1-9 |
| Set of 10-18 | 264XX-10-18 |



Gimme PG Markers w/ Chrome Base

| Decal: | Chrome Base |
|--------------|----------------|
| Blank | 264XX-BLANK/CH |
| Set of 1-9 | 264XX-1-9/CH |
| Set of 10-18 | 264XX-10-18/CH |

A 28" tall gimme marker with a 1/2" thick fiberglass woodgrain rod and a cast aluminum head. The head can be customized with your own logo decal or a sponsor. (e.g., For a blank green gimme head use 264GR-WOOD).



Fiberglass Wood Grain Gimme PG Markers w/ Plastic Base [No. 264-WOOD]



Fiberglass Wood Grain Gimme PG Markers w/ Chrome Base [No. 264-WOOD/CH]

PRACTICE GREENS POLES AND BASES

Made with fiberglass rod, the poles come with plastic, chrome or target base.



Practice Greens Flag Poles

| Base: | White Rod | Yellow Rod |
|--------------|-----------|------------|
| Chrome Base | 272WH-CH | 272YE-CH |
| Plastic Base | 272WH | 272YE |
| Target Base | 272WS | 272YS |

Javelin poles are tapered to 3/4" in the middle making them stronger.

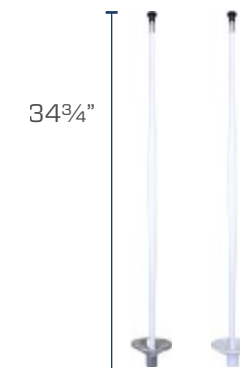

Javelin Practice Greens Poles

| Base: | Javelin Rod |
|--------------|-------------|
| Chrome Base | 272WH-J/CH |
| Plastic Base | 272WH-J |

Chromium on metal provides corrosion resistance and increases surface hardness. Plastic is a light and more economical alternative to the chrome base.



Practice Chrome & Plastic Green Bases

| Opening: | Chrome Base | Plastic Base |
|----------|-------------|--------------|
| 5/16" | 278-2CH | P275-2 |
| 3/8" | 278-6CH | P275-3 |
| 1/2" | 278-7CH | P275-5 |

Introducing our 1" Brazilian IPE hardwood putting green pole, eight times harder than California Redwood and naturally resistant to rot. Finished with multiple coats of marine-grade varnish for added durability.



Striped Practice Greens Flag Poles

| Base: | White Rod | Yellow Rod |
|--------------|-------------|-------------|
| Chrome Base | 272WH-BK/CH | 272YE-BK/CH |
| Plastic Base | 272WH-BK | 272YE-BK |
| Target Base | 272WH-BK/S | 272YE-BK/S |



Hardwood Practice Green Flag Pole [No. 272JWOOD]

Our 1/2" Fiberglass Woodgrain Practice Green Flag Pole is an inexpensive option to achieve the woodgrain look.

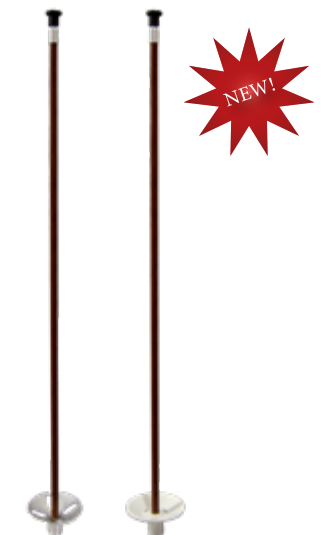

Fiberglass Wood Grain Practice Greens Flag Poles

| Base: | Fiberglass Wood Grain |
|--------------|-----------------------|
| Chrome Base | 272WOOD-CH |
| Plastic Base | 272WOOD |

PRACTICE AND RANGE

6X8" PRACTICE GREENS FLAGS

Made of durable 400 Denier Solar Max material complete with a tube locking attachment.

- Red
 - White
 - Blue
 - Yellow
 - Green
 - Orange
 - Black
 - Purple
 - Pink
- *Custom colors available.



6x8" Nylon Practice Greens Tube Flag [No. 273T]

Made of double sided Dura material and dye sublimated for added durability. Complete with a tube locking attachment.

- ◐ Blue/White
 - ◐ Red/White
 - ◐ Black/White
 - ◐ Green/White
 - ◐ Yellow/Black #'s
 - ◐ Black/Black
 - ◐ Red/Black #'s
 - ◐ Green/White #'s
- *Custom colors available.



6x8" Checkered Practice Greens Tube Flag [No. 273CHT]

Made of double sided Poplin material and dye sublimated for added durability. Complete with a tube locking attachment.

- ◐ White/Black #'s
 - ◐ Yellow/Black #'s
 - ◐ Blue/White #'s
 - ◐ Red/White #'s
 - ◐ Green/White #'s
 - ◐ Black/Black
 - ◐ Red/Black #'s
 - ◐ Green/White #'s
- *Custom colors available.



6x8" Numbered Tube Flag [No. 273T]
Sold only in sets of 1-9 or 10-18.

Specialty Practice Greens Flags

Made of double sided Poplin material and dye sublimated for added durability, making them less vulnerable to fading and eliminating peeling. Complete with a tube locking attachment.



6x8" Marshall Flag [No. 273MART]



6x8" Canadian Flag [No. 273CANT]



6x8" Ranger Flag [No. 273RANT]



6x8" Handicap Flag [No. 273HCPT]



6x8" American Flag [No. 273AMERT]

PRACTICE AND RANGE

18X26" RANGE FLAGS

Made of durable 400 Denier Solar Max material complete with a tube locking attachment.

- Blue
 - Red
 - Green
 - Gold
 - Orange
 - Yellow
 - White
 - Light Blue
 - Brown
 - Pink
 - Black
 - Purple
 - Burgundy
 - Hunter Green**
- *Custom colors available
**WGL



18x26" Nylon Range Flags [No. 1009]

Made of double sided Dura material and dye sublimated for added durability. Complete with a tube lock attachment.

- ◐ Green/White
 - ◐ Yellow/White
 - ◐ Blue/White
 - ◐ Black/White
 - ◐ Black/Black
 - ◐ Black/Black
 - ◐ Red/White
 - ◐ Orange/White
- *Custom colors available



18x26" Checkered Range Flags [No. 1008CHT]

CHIPPING GREENS BALL PUSHER

This easy to use ball pusher is perfect for the practice chipping green. It allows golfers to sweep balls quickly and effectively.

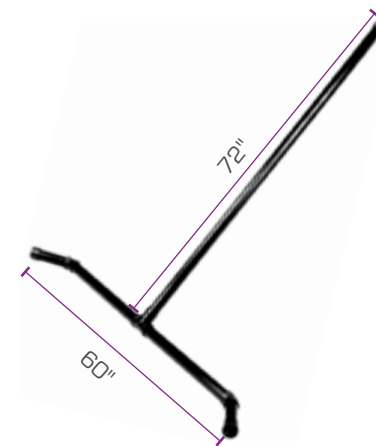

Chipping Greens Ball Pusher [No. 132]

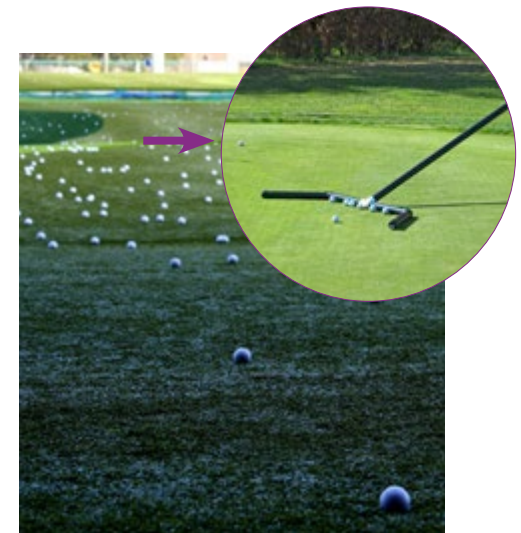

RANGE CLUB WASHERS

Heavy-duty polyethylene body & cover. Holds two 12" x 12" bristle brushes that can be rotated for maximum utilization. Handles on either side for lifting & moving. Cover has 6" opening for easy access. No wires, clamps or screws required. Will not lift during use.



Black Range Club Washer [No. 695BK]



Green Range Club Washer [No. 695GR]

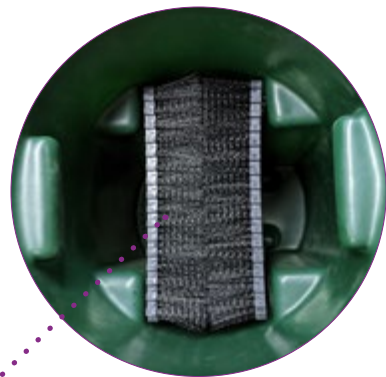

Club Washer Brush [No. 405]

12" x 12" replacement brush for 695 Range Club Washer. Perfectly symmetrical on all sides allows for rotation and maximum utilization. Sold individually. Each club washer requires 2 brushes.

CUSTOM RANGE DIVIDERS

Our custom 4"x32" range dividers are an excellent solution for separating and organizing different areas of the driving range. These double-sided dividers are made from lightweight corrugated plastic and are securely mounted with two single ground spikes for easy installation.

Please inquire for more details and pricing.



RANGE BANNERS

Range Banners made of heavy duty dye-sublimated (no peeling) polyester and durable PVC pipe.

Numbered 25-300 in 25 yard increments. Some assembly required.



| YARDAGE | BANNER ONLY | | COMPLETE UNIT | |
|----------------|-------------|------------|---------------|------------|
| | VERTICAL | HORIZONTAL | VERTICAL | HORIZONTAL |
| 25 YDS | VRB025 | RB025 | COMVRB025 | COMRB025 |
| 50 YDS | VRB050 | RB050 | COMVRB050 | COMRB050 |
| 75 YDS | VRB075 | RB075 | COMVRB075 | COMRB075 |
| 100 YDS | VRB100 | RB100 | COMVR100 | COMRB100 |
| 125 YDS | VRB125 | RB125 | COMVR125 | COMRB125 |
| 150 YDS | VRB150 | RB150 | COMVR150 | COMRB150 |
| 175 YDS | VRB175 | RB175 | COMVR175 | COMRB175 |
| 200 YDS | VRB200 | RB200 | COMVR200 | COMRB200 |
| 225 YDS | VRB225 | RB225 | COMVR225 | COMRB225 |
| 250 YDS | VRB250 | RB250 | COMVR250 | COMRB250 |
| 275 YDS | VRB275 | RB275 | COMVR275 | COMRB275 |
| 300 YDS | VRB300 | RB300 | COMVR300 | COMRB300 |

Horizontal and Vertical Range Banners - Complete Units or Banners Only
Framing Kit Only [No. RBKIT]



Sand/Seed Bottle w/ Handle
Part No. 234H
Page 14

Recycled Plastic Bench
Part No. EE1214
Page 18

Double Brush Stand
Part No. 686
Page 73

| | |
|-------------------------------|----|
| SPIKE CLEANER STANDS & MOUNTS | 73 |
| BRUSH ASSEMBLIES | 73 |
| REPLACEMENT BRUSHES | 73 |
| ASSEMBLES | 73 |
| OTHER FURNITURE | 74 |
| ECO BLAST AIR HORNS | 74 |
| PROXIMITY MARKERS | 75 |
| UNIVERSAL FLAG HOLDER | 75 |

SPIKE CLEANER STANDS AND MOUNTS

The brush spike cleaner stands are constructed of 1" steel tubing with flange base. The base can be secured to a hard surface with lag bolts, or onto grass/other ground surface with four 6" long spikes (all necessary hardware is provided).



Double Brush Spike Cleaner Stand [No. 680 or 680BK for black flange]



Double Brush Spike Cleaner Stand with Side Brushes [No. 687 or 687BK for black flange]

Single or double mount with spike cleaner brushes. Wraps around our ball washer ensemble 2" pipe. Available unpainted only.

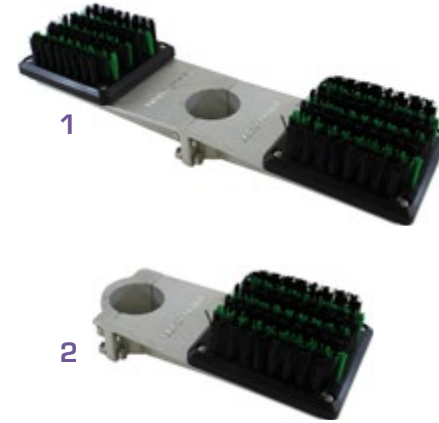

**1. Double Mount with Brushes [No. 675]
2. Single Mount with Brush [No. 670]**

BRUSH ASSEMBLIES

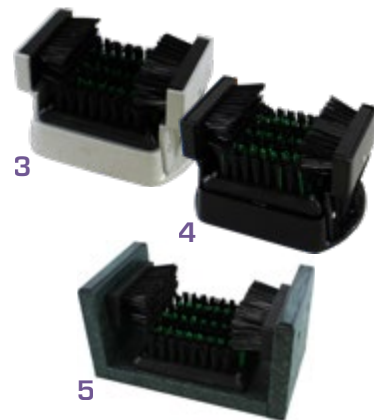

**3. Brush Assembly w Side Brushes [No. 606]
4. Black Brush Assembly w Side Brushes [No. 606BK]
5. Recycled Plastic Brush Assembly [No. E601] (comes with spikes)**



**6. Brush Assembly [No. 600] Holder Only [No. 605]
7. Black Brush Assembly [No. 600BK] Holder Only [No. 605BK]**

REPLACEMENT BRUSHES



**8. Side Brush w/ Hardware [No. 606-2]
9. Base Brush w/ Hardware [No. 610]**
Brush screws into 701 Base.

OTHER PRO-SHOP & CLUBHOUSE FURNITURE



Modular golf bag rack made of durable heavy duty metal with powder coated finish. They can be assembled to any length in multiples of 3', or be set back to back. Sold as a pack of two racks, holds up to 6 golf bags. All necessary hardware included.
No. 780BK shown in photo.

**Golf Bag Racks [No. 780BK-6] (double)
Golf Bag Racks [No. 780BK-3] (single)**

AIR HORNS

Eco-Blast Air Horns are powerful, USGA approved sound emitters that can be recharged with almost any pump. They both emit approx. 115-120 dB.



**1. Eco-Blast Air Horn [180] (comes with pump)
2. Eco-Blast Air Pro Horn [180PRO] (can be recharged w/ most pumps)**

PROXIMITY MARKERS

Sturdy nickel plated metal frame complete with 25 cards (double sided). Refill cards are available in pack of 25.

Pack of four Proximity Markers, each complete with its own pack of 25 cards.

Double sided, thick cardboard Proximity/Long Drive cards. Pack of 25.

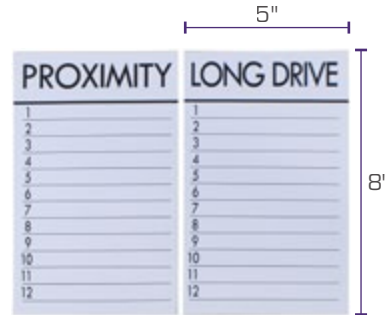

Proximity Markers [No. 517WH]

Proximity Markers - 4 pack [No. 517WH-4]

Proximity/Long Drive Cards [No. 517-2]

UNIVERSAL FLAG HOLDER

Our Universal Flag Holder allows you to attach a flag to virtually any cart. It features a 2' white pole and either a 6x8" (DS) or 14x20" (SS) handicap flag.

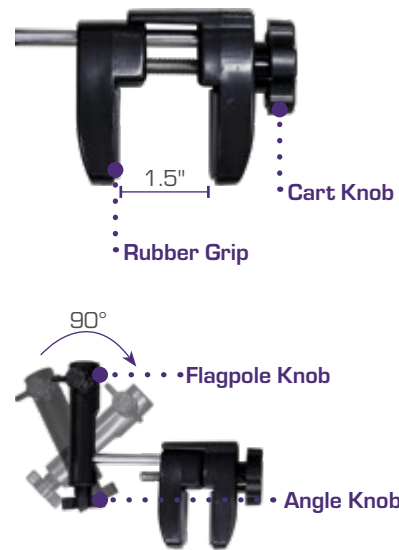

Would you like a different pole or flag? Purchase the holder only and/or the rod only separately. Please contact us for more information.



Universal Flag Holder with Flag
 6x8" Handicap Flag [No. 346HDCP-1]
 14x20" Handicap Flag [No. 346HDCP-2]
 6x8" Canadian Flag [346CANT]
 6x8" American Flag [346AMERT]

Other flags can be attached, as well.

1. Rod Only [No. 346ROD]
 2. Universal Holder Only [No. 346]

CLEARANCE SALE

UP TO 50% OFF

CLEARANCE

Please contact us for the most up to date availability of clearance items.

Made of cast aluminum and powder coated black, this mount allows you to install the litter bins to any wall. Hardware not included.



Litter Bin Wall Mount [No. 749]

Made of strong plastic, this placement marker slides onto the flag poles. It is equipped with a rubber ring which holds the ball in place.



Plastic Placement Markers [No. 324]

Made of cast aluminum and powder coated black, with an unpainted or black reel. Rope extends up to 25' in length and the reel automatically collects the rope.



EZ Aluminum Rope Stakes

| Height: | Unpainted Reel | Black Reel |
|---------|----------------|------------|
| 24" | 284UP | 284BLACK |
| 40" | 285UP | 285BLACK |

Maintenance free, UV resistant, plastic markers. Cross-shaped structure with beveled tip makes for easy installation & replacement.

● Blue ● Red ○ White ● Blue ● Red ○ White



SMP Fairway Distance Markers [No. 293]

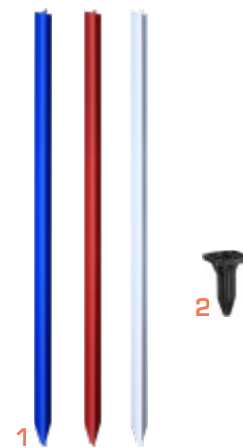

Replacement SMP Parts

1. Replacement Stake [No. 293-01]
2. Replacement Base [No. 293-02]

A 12 prong litter stick with a quick release trigger. Made with durable aluminum handle and hard, heavy duty plastic.

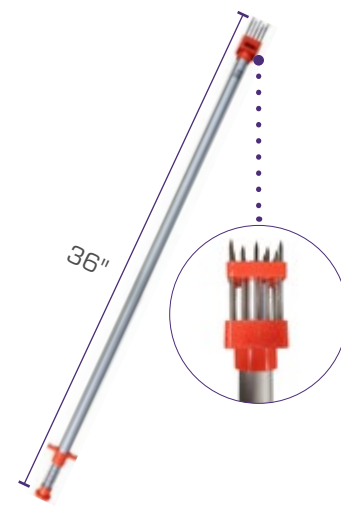

E-Z Litter Stick (*WQL) [No. EZL3612]

ABOUT BAYCO

Our Name Stands for *Quality*

Bayco Golf started out unlike the typical business. The founder, Alex Colonelo, came from a mechanical toolmaker background. He started working at a company called Bay Bronze Industries which manufactured fuel fittings and plumbing parts as well as bronze signs and plaques. His passion for golf and his experience in manufacturing inspired him to start a golf course accessories division within Bay Bronze in 1986 (renamed to Colon Industries at this time). In 1998, he bought off the golf division and named the company Bayco Golf Inc where he became a president. He retired in 2006 when OSC Seeds purchased Bayco Golf and a new general manager, Cal Surgenor, was appointed. Cal has guided the continuing growing process of Bayco for over 15 years.



Bayco Golf has always strives to bring the best quality of products to the golf course accessory market. With our knowledgeable team and many years of experience, you can remove all uncertainty with anything related to your course. We build meaningful relationships with clients that last a lifetime. We pride ourselves that almost all of our products are manufactured locally in North America. We are a forward thinking, market improving company that has set the bar for numerous products, including Dye Sublimated Custom Flags, Pro Hole Cups with Liner and Locking Ferrule, ColorFlex Distance Markers, the Mully Cup Lifter, our newly designed InstaFix Ball Mark Repair Tool, and so much more.

The little train that could – did. We are one of the top manufacturers/suppliers in the world. We ship internationally in over 50 countries and our products are found on the most prestigious golf courses in the world. We design custom flags, markers, cup liners, plaques, signs and more! Our customers vary from a private individual who wants to build a small putting green in their back yard, to 36-hole resort golf courses around the world.

If you are looking for a reliable and knowledgeable staff to help you with your golf course accessory needs, look no further! Call us today and we would be happy to help you!

Get on course with **BAYCO!**

INDEX

| | | | |
|--|----|---------------------------------|----|
| A | | | |
| Aluminum Club Washers | | Sand and Seed Bottle Holder | 14 |
| Replacement Brush | 11 | Sand and Seed Bottle Rack | 13 |
| B | | E | |
| Ball Washers | | Eco-Blast Air Horns | 74 |
| Ball Washer Wall Mount | 12 | Ensembles | |
| Ensemble Examples | 8 | Ball Washer Stand Base | 11 |
| Model 699 Plunger Style Ball Washer | 10 | Ensemble Examples | 8 |
| Model 700 Plunger Style Ball Washer | 10 | Foot Brush with Screws | 12 |
| Model 770 Customizable Plunger Style Ball Washer | 10 | Stainless Steel Spikes for Base | 12 |
| Plunger Style Repair Kit | 12 | Stand Pipes | 11 |
| C | | F | |
| Clearance | | Fairway Markers | |
| EZ Aluminum Rope Stakes | 77 | Color Flex Distance Markers | 26 |
| Litter Bin Wall Mount | 77 | Color Flex Installation Kit | 26 |
| Plastic Placement Markers | 77 | Color Flex Replacement Markers | 26 |
| SMP Fairway Distance Markers | 77 | Domed Aluminum Distance Marker | 26 |
| Coco Drag Mat | 46 | Domed Polymer Distance Marker | 26 |
| Cups | | Recycled Plastic Hazard Markers | 26 |
| Aluminum Cups | | Flagpoles | |
| 4.25x4.25" Aluminum Greens Cup | 33 | Bayco Guard for Flag Poles | 41 |
| 6x4.25" Aluminum Green Cup | 33 | Flag Pole Holder Kit - American | 42 |
| 6x4.25" Aluminum Pro Hole Cup | 34 | Flag Pole Holder Kit - Canadian | 42 |
| Aluminum Cup Setter | 35 | Flag Pole Holder Only | 42 |
| Cup Pullers | | Mully Cup Lifter | 41 |
| Double Prong Cup Puller | 32 | Reflectors | |
| Single Prong Cup Puller | 32 | Bayco Laser Reflectors | 41 |
| Three Prong Cup Puller | 32 | Elite Laser Reflector | 41 |
| Curved Trimming Scissors | 32 | DIY Laser Reflector | 41 |
| Green Plastic Cup Cover | 35 | Flags | |
| Hole-In-White | | 6x8" Checkered Tube Flags | 67 |
| Aluminum Paint Tool | 32 | 6x8" Numbered Tube Flags | 67 |
| Cup Protector | 32 | 6x8" Nylon Tube Flags | 67 |
| Paint Applicator | 32 | 14x20" Checkered Tube Flags | 44 |
| Plastic Cups | | 14x20" Country Flags | 43 |
| 4.25x4.25" Plastic Greens Cup | 33 | 14x20" Numbered Tube Flags | 44 |
| 6x4.25" Plastic Cup with Bronze Insert | 33 | 14x20" Nylon Tube Flags | 43 |
| 6x4.25" Plastic Greens Cup | 33 | 14x20" Special Event Flags | 44 |
| SpeedWrap Cup Liners | 34 | 18x26" Checkered Tube Flags | 68 |
| Cup Sleeves | 36 | 18x26" Nylon Tube Flags | 68 |
| D | | Custom Flags | 2 |
| Detergents | | Flag Accessories | |
| Heavy Duty Detergent | 11 | Acorn Nut | 43 |
| Soap Tablets | 11 | Quick Click | 43 |
| Dew Whipping Pole | 46 | Security Nut | 43 |
| Divot Mix / Sand and Seed | | Furniture | |
| Divot Mix Containers | 13 | Benches | |
| Personal Sand and Seed Bottle | 13 | 5' Deco Bench | 18 |
| | | 6' Deco Bench | 18 |
| Plastic Scoops | 13 | 6' Standard Bench | 18 |
| Rattle Proof Sand and Seed Bottle | 14 | Golf Bag Racks | 74 |
| Rattle Proof S&S Bottle with Molded In Handle | 14 | Water Coolers | |
| Replacement Screw-On Caps | 14 | 4 oz Solo Cups | 18 |
| | | 5 Gal. Water Cooler | 17 |

INDEX

| | | | |
|--|----|--|--------|
| 10 Gal. Water Cooler | 17 | | |
| Lever Style Spigot | 18 | | |
| Lock and Key | 18 | | |
| Pinch Tube Spigot | 18 | Gimme PG Markers | 65, 66 |
| Plastic Bracket | 18 | Javelin Practice Greens Poles | 66 |
| Plastic Cup Dispenser | 18 | Practice Greens Flag Poles | 66 |
| Push Button Spigot | 18 | Proximity Markers | 75 |
| Steel Bracket | 18 | R | |
| Steel Cup Dispenser | 18 | Rope | |
| G | | Bungee Rope | 27 |
| Greens Speedmeter | 46 | Custom Rope Stakes | 27 |
| H | | Recycled Plastic Rope Stakes | 27 |
| Hole Cutters | | Three Strand Braided Rope | 27 |
| Red Hole Cutter Guide | 31 | S | |
| Hole Cutter Flanged Stop | 31 | Sand Trap Rakes | |
| Lever Style Hole Cutter | 31 | Bayco Shrink Guard for Rake Handles | 45 |
| Replacement Blades | 31 | Disc Tooth Rake Head | 45 |
| Wide Hole Cutter | 31 | Fiberglass Handle | 45 |
| I | | Lightweight Rake Head | 45 |
| InstaFix Ball Mark Repair Tool | 46 | Octagon Rake Head | 45 |
| L | | Wooden Handle | 45 |
| Litter Baskets and Bins | | Signage | |
| Designer Series Litter Bin | 16 | Aluminum Spikes | 56 |
| Designer Series Litter Bin Lids | 16 | Customizable Aluminum Signs | 56 |
| Designer Series Litter Bin Mounting Brackets | 16 | Heavy Duty Steel Signs | 55 |
| Designer Series Litter Bin Stands | 16 | Two Sided Aluminum Directional Signs | 56 |
| Litter Basket Bases | 15 | Spike Cleaners | |
| Litter Baskets | 15 | Brush Assemblies | 73 |
| Litter Basket Stand Base Mount | 15 | Double Brush Spike Cleaner Stand | 73 |
| M | | Double Brush Spike Cleaner Stand with Side Brushes | 73 |
| Maintenance | | Double Mount with Brushes | 73 |
| Aluminum Landscaper | 61 | Replacement Brushes | 73 |
| E-Z Litter Stick | 77 | Single Mount with Brush | 73 |
| E-Z Reacher | 62 | T | |
| Greens Section Soil Sampler | 59 | Tee Markers and Caddies | |
| Plug Pusher | 62 | Broken Tee Caddies | |
| Roller Squeegee | 61 | Aluminum Broken Tee Caddy | 19 |
| SOLO Back Pack Sprayer | 62 | Plastic Broken Tee Caddy | 19 |
| P | | Recycled Plastic Broken Tee Caddy | 19 |
| Paint and Marking | | Tee Markers | |
| Marking Pistol | 28 | 3" Solid Plastic Tee Marker | 21 |
| Marking Wand | 28 | 5" Hollow Plastic Tee Marker | 21 |
| Rust-Oleum Precision Line Marking | 28 | 5" Hollow Tee Marker w/ Plastic Base | 21 |
| Practice and Range | | 5" Solid Plastic Tee Marker | 21 |
| Chipping Greens Ball Pusher | 68 | Recycled Plastic Cube Tee Markers | 21 |
| Driving Range | | Solid Aluminum Tee Marker | 20 |
| 18x26" Checkered Tube Flags | 68 | Tear Drop Tee Marker | 20 |
| 18x26" Nylon Tube Flags | 68 | Tee Towels | |
| Club Washer Brush | 69 | Classic Tee Towel | 17 |
| Range Banners | 70 | Elite Cotton Center Grommet Towel | 17 |
| Range Club Washer | 69 | Premium Tee Towel | 17 |
| Practice Greens | | U | |
| 6x8" Checkered Tube Flags | 67 | Universal Flag Holder for Carts | 42, 75 |
| 6x8" Numbered Tube Flags | 67 | W | |
| 6x8" Nylon Tube Flags | 67 | White Plastic Cup Ring | 36 |
| Chrome & Plastic Bases | 66 | | |

Get on course with **BAYCO!**

Customize your golf course accessories for 2024.
With a range of flags, tee markers and signs, you will find the right product to make your course stand out.

877.668.4653
BaycoGolf.com

www.BAYCOGOLF.com



BAYCO GOLF
206 Saulteaux Cres.
Winnipeg, MB R3J 3W3
Ph: (204) 633-8881
Fax: (204) 633-6226
Toll Free: 1 (877) 668-4653
E-Mail: contact@baycogolf.com

DISTRIBUTED BY:

RETURN POLICY

Bayco Golf strives for complete customer satisfaction at all times, however, in the unlikely event you are not completely happy with your purchase you may request a refund. All refund requests must be made within 7 days of delivery date. Please include your invoice number and name when contacting us. All items must be in a new/unused condition, in original packaging, and with all paperwork, parts, and accessories. Once the merchandise has been received and passed a satisfactory inspection, a refund will be issued onto the original method of payment and in the original currency (less the outbound and inbound shipping fees, where applicable). All returned items are subject to a \$10 restocking fee.

Exchange of items is only accepted if the item is damaged or has manufacturer's defects (proof upon request is needed). In this case, Bayco Golf will cover the shipping costs. If the item cannot be repaired, we will replace the item and send it back to the Customer at our own expense.

Exception to items include:

- Clearance Items - these are discontinued items that we wish to sell out of. We regret to say that items purchased as "Clearance" are not eligible for returns or exchanges.
- Custom Items - Custom items cannot be resold and therefore we cannot accept returns on them. Please note that it is the **Customer's responsibility** to ensure clarity in communication and to approve provided proofs for custom work. However, if a mistake is made on our end, Bayco Golf will re-do and replace the merchandise at no expense to the customer.
- Any other item that cannot be re-sold, that includes but is

not limited to items in used condition that do not qualify for our warranty or items reduced due to damage or defect and marked as final sale.

We reserve the right to warn, limit or decline returns or exchanges regardless if the item answers to all the conditions mentioned above. Notwithstanding, we may change or modify the agreement in part or completely without notice and we will not be held responsible for any loss or damage suffered as a result of such changes.

WARRANTY

Bayco Golf warrants products to be free from defects in materials and workmanship under correct use and proper applications for a period of six (6) months or one golf season from the original date of purchase. Warranty requests must be made immediately upon finding a defect and proof must be provided. The suitability whether the merchandise satisfies the conditions of the warranty are determined entirely by Bayco Golf. After passing a satisfactory inspection and concluding that the damage falls under the warranty, Bayco Golf's obligations are limited to the repair or exchange of the item at no cost to the client. Should the merchandise not satisfy the conditions of the warranty, Bayco Golf reserves the right to refuse or otherwise limit the return/repair/exchange of the item. **The warranty does not cover damages due to negligence, improper use or maintenance, weather conditions, theft, or natural disasters.**